

Engineering Data
AC Servo Drive HA-680

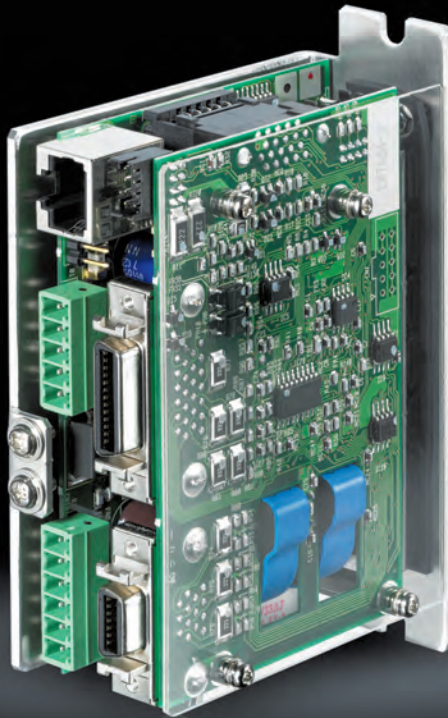

Harmonic
Drive AG



QUICKLINK

www.harmonicdrive.de/1110

SAFETY GUIDE

For FHA series, RSF series, HA series

Read this manual thoroughly before designing the application, installation, maintenance or inspection of the actuator.



Indicates a potentially hazardous situation, which, if not avoided, could result in death or serious personal injury.



Indicates a potentially hazardous situation, which, if not avoided, may result in minor or moderate personal injury and/or damage to the equipment.

LIMITATION OF APPLICATIONS:



The equipment listed in this document may not be used for the applications listed below:

- | | |
|---|---|
| <ul style="list-style-type: none"> ■ Space equipment ■ Aircraft, aeronautic equipment ■ Nuclear equipment ■ Household apparatus ■ Vacuum equipment | <ul style="list-style-type: none"> ■ Automobile, automotive parts ■ Amusement equipment, sport equipment, game machines ■ Machine or devices acting directly on the human body ■ Instruments or devices to transport or carry people ■ Apparatus or devices used in special environments |
|---|---|





If the above list includes your intending application for our products, please consult us.

Safety measures are essential to prevent accidents resulting in death, injury or damage of the equipment due to malfunction or faulty operation.





SAFETY FOR ACTUATOR DESIGN

 <p>Always use under followings conditions:</p> <ul style="list-style-type: none"> ■ Ambient temperature: 0°C to 40°C ■ Ambient humidity: 20% to 80% RH (Non-condensation) ■ Vibration: Max 24.5 m/S² ■ No contamination by water, oil ■ No corrosive or explosive gas 	 <p>Follow exactly the instructions in the relating manuals to install the actuator in the equipment.</p> <ul style="list-style-type: none"> ■ Ensure exact alignment of motor shaft center and corresponding center in the application. Failure to observe this caution may lead to vibration, resulting in damage of output elements.
--	---





SAFETY FOR ACTUATOR IN OPERATION

 <p>Keep limited torques of the actuator.</p> <ul style="list-style-type: none"> ■ Keep limited torques of the actuator. ■ Be aware, that if arms attached to output element hits by accident an solid, the output element may be uncontrollable. 	 <p>Never connect cables directly to a power supply socket.</p> <ul style="list-style-type: none"> ■ Each actuator must be operated with a proper driver. ■ Failure to observe this caution may lead to injury, fire or damage of the actuator.
 <p>Do not apply impacts and shocks</p> <ul style="list-style-type: none"> ■ Do not use a hammer during installation ■ Failure to observe this caution could damage the encoder and may cause uncontrollable operation. 	 <p>Avoid handling of actuators by cables.</p> <ul style="list-style-type: none"> ■ Failure to observe this caution may damage the wiring, causing uncontrollable or faulty operation.

SAFETY FOR CONTROLLER DESIGN

 <p>Always use drivers under followings conditions:</p> <ul style="list-style-type: none"> ■ Mount in a vertical position keeping sufficient distance to other devices to let heat generated by the driver radiate freely. ■ Ambient temperature: 0 (C to 50(C ■ Ambient humidity: Less than 95% RH (Non condensation) ■ No contamination by water, oil or foreign matters ■ No corrosive, inflammable or explosive gas ■ No water or oil near devices 	 <p>Use sufficient noise suppressing means and safe grounding.</p> <ul style="list-style-type: none"> ■ Keep signal and power leads separated. ■ Keep leads as short as possible. ■ Ground actuator and driver at one single point, minimum ground resistance class: D (less than 100 ohms) ■ Do not use a power line filter in the motor circuit.
 <p>Pay attention to negative torque by inverse load</p> <ul style="list-style-type: none"> ■ Inverse load may cause damages of drivers. ■ Please consult our sales office, if you intent to apply products for inverse load. 	 <p>Use a fast-response type ground-fault detector designed for PWM inverters.</p> <ul style="list-style-type: none"> ■ Do not use a time-delay-type ground-fault detector.

SAFETY FOR CONTROLLER IN OPERATIONS

 <p>Never change wiring while power is active.</p> <ul style="list-style-type: none"> ■ Make sure of power non-active before servicing the products. ■ Failure to observe this caution may result in electric shock or personal injury. 	 <p>Use the specified power supply</p> <ul style="list-style-type: none"> ■ To supply power to the 24 VDC driver (HA-680 Series), use the secondary-side power supply with double insulation from the primary side.
 <p>Do not make a voltage resistance test.</p> <ul style="list-style-type: none"> ■ Failure to observe this caution may result in damage of the control unit. ■ Please consult our sales office, if you intent to make a voltage resistance test. 	 <p>Do not operate control units by means of power ON/OFF switching.</p> <ul style="list-style-type: none"> ■ Start/stop operation should be performed via input signals. <p>Failure to observe this caution may result in deterioration of electronic parts.</p>

DISPOSAL OF AN ACTUATOR, A MOTOR, A CONTROL UNIT AND/OR THEIR PARTS

 <p>All products or parts have to be disposed of as industrial waste.</p> <ul style="list-style-type: none"> ■ Since the case or the box of drivers have a material indication, classify parts and dispose them separately.

Content:

1.	Characteristics of the HA-680 drive.....	7
1.1	Main features.....	7
1.2	Model of HA-680 drive.....	7
1.3	Combinations with actuators.....	8
1.4	Specifications of HA-680 drives.....	9
1.5	External drawing of the HA-680 drive.....	10
1.6	Names and functions of parts.....	11
1.7	Overview of I/O ports.....	12
1.7.1	TB2: Power supply connection terminal.....	12
1.7.2	TB1: Actuator connection terminal.....	12
1.7.3	CN1: Encoder connector.....	13
1.7.4	CN3: Serial port connector.....	13
1.7.5	CN4: CAN connector.....	13
1.8	CN2 Inputs and Outputs.....	14
1.9	LED display.....	16
1.10	Outline of protective functions.....	16
1.11	Protective functions.....	17
2.	I/O ports.....	19
2.1	Assignment of I/O signals.....	19
2.1.1	Assignment of input signals.....	19
2.1.2	Assignment of output signals.....	20
2.1.3	Type of I/O signal connector CN2.....	20
2.2	Position control	21
2.2.1	I/O port layout.....	21
2.2.2	I/O port connections in the position control.....	21
2.2.3	I/O port functions in the position control.....	22
2.2.4	Connection examples in the position control.....	28
2.3	Speed control.....	30
2.3.1	Pin numbers and names of I/O signals.....	30
2.3.2	I/O port connections in the speed control.....	30
2.3.3	I/O port functions in the speed control.....	31
2.3.4	Connection examples in the speed control.....	37
2.4	Torque control.....	38
2.4.1	Pin numbers and names of I/O signals.....	38
2.4.2	I/O port connections in torque control.....	38
2.4.3	I/O port functions in torque control.....	39
2.4.4	Connection examples in torque control.....	44
2.4.5	Encoder connection HA-680-CN1.....	45

3.	Installing HA-680 drive.....	47
3.1	Receiving inspection.....	47
3.2	Handling.....	48
3.3	Location and installation.....	48
3.3.1	Environment of location.....	48
3.3.2	Installation.....	49
3.3.3	Installing.....	49
3.4	Suppressing noise.....	50
3.4.1	Grounding.....	50
3.4.2	Installing noise filters.....	50
3.4.3	Cabling.....	51
3.5	Connecting power cables.....	52
3.5.1	Instructions for power supply.....	52
3.5.2	Allowable size of cables.....	52
3.5.3	Connecting power cables.....	53
3.6	Connecting the ground wire.....	54
3.7	Connecting the motor and regeneration resistor cables.....	54
3.8	Connecting regenerative absorption resistance / capacitor.....	54
3.9	Connecting cables for the encoder and the I/O.....	56
3.9.1	Preparing the encoder cable and the I / O cable.....	56
3.9.2	Pin layout of encoder connector (CN1).....	56
3.9.3	Pin-layouts of the I/O signal connector (CN2).....	57
3.9.4	Connecting cables for the encoder and I/O signals.....	57
3.9.5	EIA-232C (RS-232C) cable specifications.....	57
3.10	Power ON and OFF sequences.....	58
3.10.1	Power ON / OFF sequence circuit.....	58
3.10.2	Frequency of power ON / OFF operation.....	58
3.10.3	Power on and off sequences.....	58
4.	Functions of dedicated communication software PSF-520.	59
5.	Operations	60
5.1	Trial run.....	60
5.1.1	Driving actuator only.....	60
5.1.2	Setting parameters.....	61
5.1.3	End of trial run.....	61
6.	Setting up parameters.....	62
6.1	Parameter list.....	62
6.2	Parameters.....	63

Content:

6.3	Default parameter list.....	79
7.	Troubleshooting.....	87
7.1	Alarms and diagnostic tips.....	87
7.2	Troubleshooting for improper actuator motions.....	94
7.2.1	Improper motions in position control.....	94
7.2.2	Improper motions in speed and torque control.....	98
8.	Options.....	102
8.1	Relay cables.....	102
8.2	Connectors.....	103
8.3	Dedicated communication software PSF-520 (free).....	103

1. Characteristics of the HA-680 drive

The HA-680 drive for 24 VDC power supply is a dedicated driver that drives the FHA-C mini 24 VAC type, an ultra-thin, hollow shaft structure actuator with a combination of an ultra-thin, precision control reduction gear Harmonic Drive® and flat AC servo motor, and the RSF supermini series, an ultra-small AC servo

actuator with a combination of an ultra-small Harmonic Drive and ultra-small AC servo motor.

The HA-680 drive provide many superior functions to allow the FHA-Cmini 24 VAC type actuators and RSF supermini series actuators excellent performance.

1.1 Main features

■ Small and compact design

It is about half the size of a postcard, just the size of a card case. Its ultra-light design with a weight of 230 g is useful for small, space-saving devices.

■ Substantial functions

Position control, speed control, and torque control are provided as standard. It is compact and has substantial functions at the same time.

■ Easy function setting

Parameters can be set easily using dedicated communication software PSF-520.

■ Wide range of operation state display

I/O signals, rotation speed, and deviation can be monitored using dedicated communication software PSF-520.

Up to eight previous alarms are also indicated in the alarm history that is helpful for diagnosis.

■ The main circuit power supply and the control power supply are separated.

Because the main circuit power supply and the control power supply are separated, safe diagnosis can be performed in case of failure.

■ Easy test run adjustment

Adjustment can be performed using dedicated communication software PSF-520.

■ Electronic gear suitable for mechanical system

The electronic gear function adjusts commands to a feed pitch of a driven mechanism such as gears or lead screws.

■ Three types of input signals for position commands

Three types of input signals for the position command are selectable: Two-pulse train, single-pulse train, and two-phase pulse train.

■ Regenerative circuit provided as standard

The drive incorporates a regenerative circuit as standard. You can use it in applications with a large moment of inertia without worrying about regeneration.

1.2 Model of HA-680 drive

Model and sign of HA-680 drive are described as follows:

Note that the model varies depending on the actuator used.

■ HA-680 drive:

HA - 6 8 0 - 4 □ - 2 4

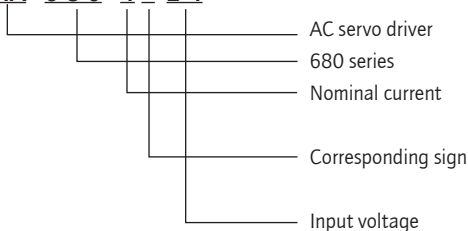

4	4A
6	6A

None	For FHA-Cmini 24 VAC type
B	For RSF series

24	24 VDC
----	--------

1.3 Combinations with actuators and cables

Servo drive	Actuator	Motor feedback Input	Motor cable	Brake cable	Encoder cable
HA-680-4B-24	RSF-3C-xxx-D020-C	8-wire encoder with HALL sensor (Open collector).	EWA-Mxx-JST04-TN2	EWA-Bxx-JST03-TMC	EWA-Exx-JST09-3M14 ¹⁾
	RSF-5B-xxx-D050-xC				
	RSF-8B-xxx-F100-24A-C	14-wire encoder with HALL sensor (RS422 line driver)	EWC-MBxx-A06-TN2	not available	EWB-Fxx-M0809-3M14 ¹⁾
HA-680-6B-24	RSF-11B-xxx-F100-24A-C				
	RSF-14B-xxx-F100-24A-C				
HA-680-4-24	FHA-8C-xxx-D200-E		not available		
	FHA-11C-xxx-D200-E		not available		
HA-680-6-24	FHA-14C-xxx-D200-E		not available		
HA-680-4-24	FHA-8C-xxx-E200-CE	4-wire encoder with serial interface	EWC-MBxx-A06-TN2	not available	EWC-Exx-M06-3M14
	FHA-11C-xxx-E200-CE				
HA-680-6-24	FHA-14C-xxx-E200-CE				

xx = 03 3 m cable length
 05 5 m cable length
 10 10 m cable length

Note 1: The encoder connecting cable includes an electronically circuit to transform the "open collector" signal into a differential signal.

1.4 Specifications of HA-680 drives

Servo drive		Unit	HA-680-4x-24	HA-680-6x-24
Supply voltage	Main circuit	VDC	24 ±15%	
	Control circuit	VDC	24 ±15%	
Rated current		Arms	4,0	6,0
Maximum current		Arms	8,4	16,5
Output voltage			sinussoidal	
Switching frequency		kHz	12,5	
Motor feedback input			"14-wire, incremental, rectangular (A, A/, B, B/, Z, Z/, U, U/, V, V/, W, W/, 5V, GND) Line receiver input (RS422)"	
Protection class			IP20	
Control mode			Position, speed, torque	
Position control			Command pulse interface	
			Open Collector (200 kHz)	Line driver (500 kHz)
Velocity control		V	±10V / Maximum speed (13 Bit)	
Torque control		V	±10V / Maximum torque (13 Bit)	
Digital inputs			5 x opto insulated	
Digital outputs			5 x Open collector opto insulated	
Encoder monitor			Line driver (A, B, Z) and open collector (Z)	
Status display			1 x LED red / 1 x LED green	
Communication			RS232 C	
Ambient temperature	Operation	°C	0 ~ 50	
	Storage	°C	- 20 ~ 85	
Humidity		%	10 ~ 90 non condensing (IEC 68-2/38)	
Vibration		m/s ²	4,9 (10 ~ 55Hz)	
Shock		m/s ²	19,6	
Dimensions		mm	115 x 34 x 79,5	
Weight		g	230	

Note 1: Parameter setting of this driver is performed depending on the actuator combined with it. It cannot be used for any other actuator.

The value of the rated output current is affected by the combination of the actuator.

The value of the output maximum current is affected by the combination of the actuator.

1.5 External drawing of the HA-680 drive

Unit: mm

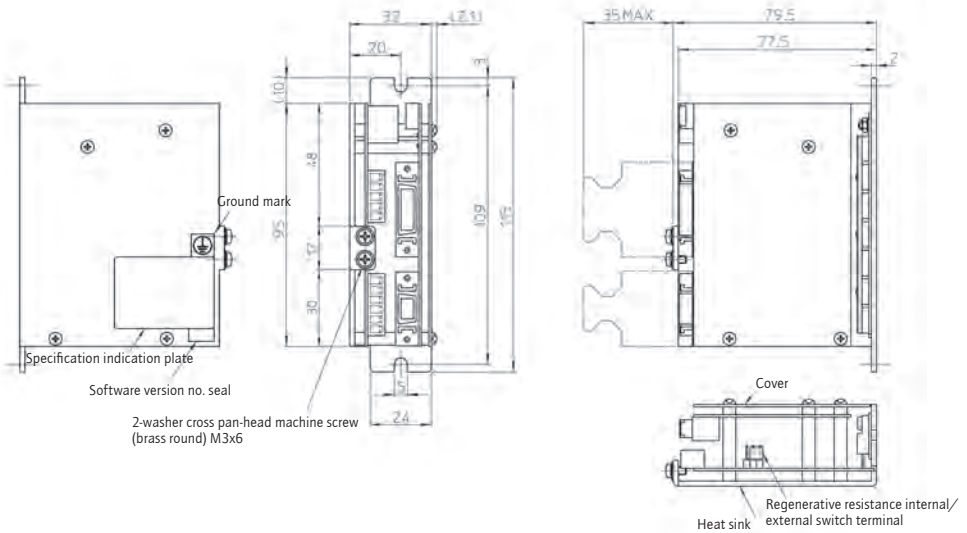

When HA-680 drive are installed in a cabinet, leave enough ventilation space for cooling as shown below.

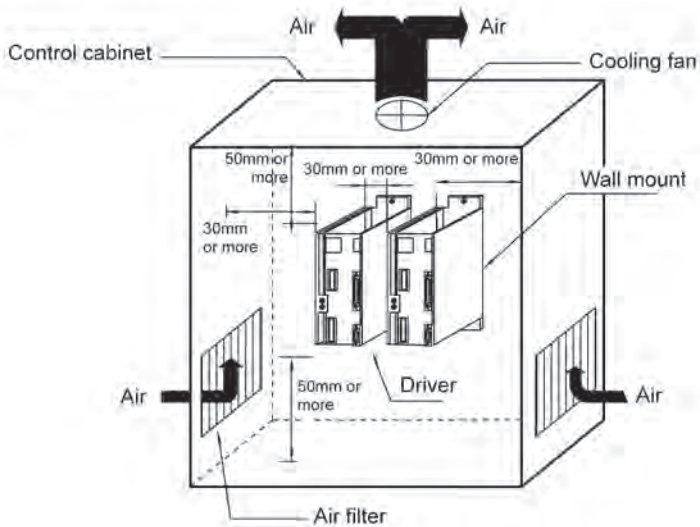

1.6 Names and functions of parts

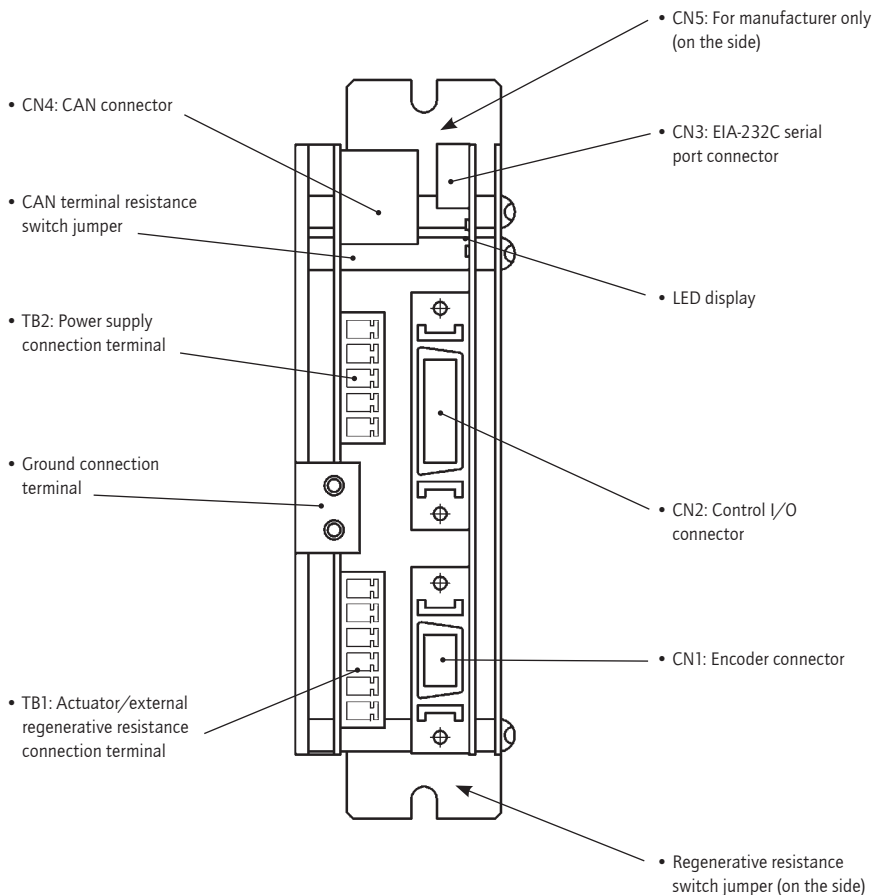

LED display unit

Displays the operation state of the HA-680 drive with the green and red LEDs.

TB2: Power supply connection terminals

The terminals for power supply. These are divided into terminals for the control circuit power supply and terminals for the main circuit power supply.

TB1: Actuator/external regenerative resistance connection terminal

The lead line of the actuator and an external regenerative resistance are connected here.

CN1: Encoder connector

The position detection encoder cable of the actuator is connected here.

CN2: Control I/O connector

This connector is for receiving control signals from the host controller.

CN3: Serial port connector

The connector for connection with a PC. This is used for monitoring the output current and setting parameters.

Connection with a PC requires dedicated communication cable "HDM-RS232C." Parameter setting requires dedicated communication software PSF-520.

CN4: CAN connector

Connector for CAN communication.

Note: Currently not available.

CN5: Not available

This connector is for the manufacturer only. The customer should never use it.

Ground connection terminal

This terminal is for grounding. Connect the ground (earth) line here to prevent electric shock.

CAN terminal resistance switch jumper

Enables or disables the terminal resistor for CAN.

Note: Currently, the CAN function is not installed. Therefore, setting this jumper is meaningless.

Regenerative resistance switch jumper

Switches between the internal regenerative resistor and the external regenerative resistor. Installing the jumper between the center pin and left pin selects the internal regenerative resistor, and installing the jumper between the center pin and right pin selects the external regenerative resistor.

For details, refer to 3.8 connecting regenerative absorption resistances/capacitors.

1.7 Overview of I/O ports**1.7.1 TB2: Power supply connection terminal**

Pin No.	Signal name	Description	
1	CP+	Control circuit power supply + (+24 VDV)	For details, refer to 3-5.
2	CP-	Control circuit power supply - (0V)	
3	MP+	Main circuit power supply + (+24 VDV)	
4	MP-	Main circuit power supply - (0 V)	
5	NC	Do not connect	

1.7.2 TB1: Actuator connection terminal

Pin No.	Signal name	Description	
1	VM	External capacitor connection terminal	For details, refer to 3-8.
2	R	External regenerative resistor connection terminal	
3	GND	External capacitor/regenerative resistor connection terminal	
4	U	Actuator U-side connection terminal	For details, refer to 3-7.
5	V	Actuator V-side connection terminal	
6	W	Actuator W-side connection terminal	

1.7.3(1) CN1: Encoder connector (For FHA-Cmini 24 VAC-type actuators)

Pin No.	Signal name	Description
1	Vcc	The power is supplied from the inside of the servo amplifier with the +5 V power supplied to the encoder.
2		
3	NC	Do not connect.
4		
5	SD+	Input terminal for the encoder data input signal from the actuator
6	NC	Do not connect.
7	SD-	Input terminal for the encoder data input signal from the actuator
8	GND	Common terminal of the +5 V power supplied to the encoder
9		
10		
11		
12	NC	Do not connect.
13		
14		

1.7.3(2) CN1: Encoder connector (For RSF series actuators and FHA-C-mini with 14 wire encoder)

Pin No.	Signal name	Description
1	Vcc	The power is supplied from the inside of the servo amplifier with the +5 V power supplied to the encoder.
2	B+	Phase B signal input+(LD)
3	Z+	Phase Z signal input +(LD)
4	B-	Phase B signal input -(LD)
5	A+	Phase A signal input +(LD)
6	Z-	Phase Z signal input -(LD)
7	A-	Phase A signal input -(LD)
8	GND	Common terminal of the +5 V power supplied to the encoder
9	U+	Phase U signal input +(LD)
10	U-	Phase U signal input -(LD)
11	V+	Phase V signal input +(LD)
12	V-	Phase V signal input -(LD)
13	W+	Phase W signal input +(LD)
14	W-	Phase W signal input -(LD)

Note 1: LD indicates the line driver.

1.7.4 CN3: Serial port connector

Pin No.	Signal name	Description
1	FG	Frame ground
2	RXD	Transmission data
3	TXD	Reception data
4	DTR	Data terminal ready
5	GND	Signal ground
6	DSR	Data set ready
7	NC	Do not connect.
8	NC	Do not connect.

(Dedicated communication cable "HDM-RS232C" is required.)

1.7.5 CN4: CAN connector

Pin No.	Signal name	Description
1	CANH	CAN-High signal
2	CANL	CAN-Low signal
3	NC	Do not connect.
4	NC	Do not connect.
5	NC	Do not connect.
6	NC	Do not connect.
7	NC	Do not connect.
8	NC	Do not connect.

1.8 CN2 Inputs and Outputs

The CN2 connector carries both input and output signals to the host control device. The connector has 26 pins, which are assigned as shown in the table below

for "position control," "speed control," and "torque control".

Position control			
Pin No.	Signal	Symbol	I/O
1	Output 1 (in-position ready)	IN-POS	Output
2	Output 2 (Alarm output)	ALARM	Output
3	Output 3	—	Output
4	Output 4	—	Output
5	Output 5 (Phase Z OC output)	Z	Output
6	Output signal common	OUT-COM	Output
7	Input 1 (Servo-ON)	S-ON	Input
8	Input 2	—	Input
9	Input 3	—	Input
10	Input 4	—	Input
11	Input 5	—	Input
12	Input signal common	IN-COM	Input
13	Encoder monitor GND	MON-GND	Output
14	FWD pulse +	FWD+	Input
15	FWD pulse -	FWD-	Input
16	REV pulse +	REV+	Input
17	REV pulse -	REV-	Input
18	+24 VDC ³⁾	+24v	Input
19	—	—	—
20	—	—	—
21	Phase A output + (LD)	A+	Output
22	Phase A output - (LD)	A-	Output
23	Phase B output + (LD)	B+	Output
24	Phase B output - (LD)	B-	Output
25	Phase Z output + (LD)	Z+	Output
26	Phase Z output - (LD)	Z-	Output

Speed control			
Pin No.	Signal	Symbol	I/O
1	Output 1 (Attained speed output)	HI-SPD	Output
2	Output 2 (Alarm output)	ALARM	Output
3	Output 3	—	Output
4	Output 4	—	Output
5	Output 5 (Phase Z OC output)	Z	Output
6	Output signal common	OUT-COM	Output
7	Input 1 (Servo-ON)	S-ON	Input
8	Input 2 (FWD start)	FWD-EN	Input
9	Input 3 (REV start)	REV-EN	Input
10	Input 4	—	Input
11	Input 5	—	Input
12	Input signal common	IN-COM	Input
13	Encoder monitor GND	MON-GND	Input
14	—	—	—
15	—	—	—
16	—	—	—
17	—	—	—
18	—	—	—
19	Speed command	SPD-CMD	Input
20	Speed command ground	SPD-GND	Input
21	Phase A output + (LD)	A+	Output
22	Phase A output - (LD)	A-	Output
23	Phase B output + (LD)	B+	Output
24	Phase B output - (LD)	B-	Output
25	Phase Z output + (LD)	Z+	Output
26	Phase Z output - (LD)	Z-	Output

Note 1: OC indicates the open collector. LD indicates the line driver.

Note 2: For terminals without a signal name for input and output, function assignment can be changed in parameter setting. For details, refer to 2.1.

Note 3: Only necessary for 24 VDC open collector systems ref. to page 27



Do not connect the pins with "—" in the Signal column to the external device. If you do, failure may occur because it is connected to the internal circuit.

Torque control

Pin No.	Signal	Symbol	I/O
1	Output 1 (attained speed)	HI-SPD	Output
2	Output 2 (alarm)	ALARM	Output
3	Output 3 (operation ready)	READY	Output
4	Output 4 (limiting current)	CUR-LMT-M	Output
5	Output 5 (phase Z Output OC)	Z	Output
6	Output signal common	OUT-COM	Output
7	Input 1 (servo-ON)	S-ON	Input
8	Input 2 (FWD start)	FWD-EN	Input
9	Input 3 (REV start)	REV-EN	Input
10	Input 4	–	Input
11	Input 5	–	Input
12	Input signal common	IN-COM	Input
13	Encoder monitor GND	MON-GND	Output
14	–	–	–
15	–	–	–
16	–	–	–
17	–	–	–
18	–	–	–
19	Torque command	TRQ-CMD	Input
20	Torque command ground	TRQ-GND	Input
21	Phase A output + (LD)	A+	Output
22	Phase A output - (LD)	A-	Output
23	Phase B output + (LD)	B+	Output
24	Phase B output - (LD)	B-	Output
25	Phase Z output + (LD)	Z+	Output
26	Phase Z output - (LD)	Z-	Output

Note 1: OC indicates the open collector. LD indicates the line driver.

Note 2: For input 4 and input 5, function assignment can be changed in parameter setting. For details, refer to 2.1.



Do not connect the pins with “-” in the signal column to the external device. If you do, failure may occur because it is connected to the internal circuit.

1.9 LED display

The 2 LEDs (green and red) indicate the state of the HA-680 drive.

State	LED green	LED red	Remarks
Control power ON	ON	OFF	
Connected actuator and driver data set do not match	Blinking	OFF	
Servo-ON	ON	ON	
Alarm (*1)	ON	Blinking	The number of times it blinks varies depending on the alarm. Refer to 1-10.
CPU error	Blinking	Blinking	The green and red LEDs blink alternately.

1.10 Outline of protective functions

The HA-680 drive has various types of protection functions. When an error occurs in the system, it immediately turns off the servo, and outputs an "alarm" signal to the host device.

When these protection functions trip, control of the actuator is stopped (the motor becomes servo-off), and the display LED blinks at 0.5-second intervals.

(It illuminates in green and blinks in red: The number of times it blinks varies depending on the alarm. See below.)

If two or more alarms occur, only the latest alarm is displayed. Up to 8 latest alarms are recorded. Recorded alarms can be checked with "Alarm History" of dedicated communication software PSF-520.

Alarm code	Description	No. of times LED blinks	Releasing
Overload	Electronic detected an overload state (I ² t monitoring).	1	Available *1
Deviation counter overflow	The value of the deviation counter exceeded the parameter setting value.	2	Available *1
Encoder break detection	The encoder line was broken.	3	Not available *2
Encoder reception error	Serial encoder data could not be received 10 times in a row.	4	Not available *2
	Serial encoder data could not be received over an extended time period, and encoder monitor could not be outputted successfully.	5	
UVW error	All UVW signals of the encoder became the same level.	6	Not available *2
Regenerative error	The main circuit voltage detection circuit detected overvoltage.	7	Not available *2
Operation temperature error	The temperature of the HA-680 main unit tripped the temperature rise sensor.	8	Not available *2
System error	An error of the current detection circuit was detected.	9	Not available *2
Overcurrent	The current detection circuit detected excessive current.	10	Not available *2
Load short circuit	Excessive current flowed through the FET.	11	Not available *2
Memory error	Read/write of EEPROM failed.	12	Not available *2
Overspeed	The motor axis speed exceeded the maximum rotation speed +100 rpm for 0.5 s or longer.	13	Not available *2

*1: The servo does not turn on unless the S-ON signal is entered again after the alarm is cleared with the CLR signal.

*2: Shut off the power supply after remedying a cause of the alarm that releasing is impossible. Then turn on the power supply.

The following example illustrates how the LED blinks in case of an alarm.

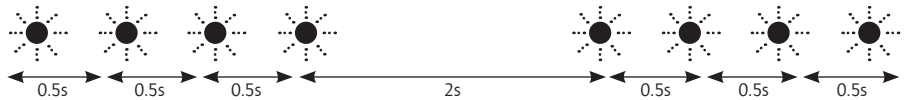

In the above example, the LED blinks 4 times at 0.5-s intervals, which indicates an "encoder reception error."

1.11 Protective functions

HA-680 drive provide the following protective functions and show the alarm displays on 1-10.

Overload (I^2t monitoring)

The driver always monitors the motor current, and if the current exceeds the curve in the figure below, the overload alarm occurs. Occurrence of the overload alarm varies depending on the actuator.

Overload alarm occurrence time

Please refer to page 89

It is possible to clear the alarm by inputting an ON signal to [CN2 Clear or Alarm clear] if it is not overload again.

Deviation counter overflow

The alarm occurs when the value of the deviation counter exceeds the parameter setting value (PSF-520 No.21 Allowable position deviation). This alarm can be reset by inputting an ON signal to "CN2 Alarm Clear: ALM-CLR" after inputting an ON signal to "CN2 Clear: CLEAR" or "CN2 Deviation Clear: DEV-CLR."

Encoder break detection

This alarm occurs when the signal from the encoder is lost. To reset the alarm, you must shut down the power and turn it on again after diagnosing and remedying the cause.

Encoder reception error

This alarm occurs when data cannot be received from the encoder successfully, or encoder signal output cannot be performed.

UVW error

The alarm occurs when the encoder UVW signals are abnormal. To reset the alarm, you must shut down the power and turn it on again after diagnosing and remedying the cause.

To clear the alarm after troubleshooting, shut off the control power once and turn it on again.

Regenerative error

The alarm occurs when the voltage of the main circuit exceeds 50 V. If the moment of inertia of the load is large, the main circuit voltage increases due to the energy generated during deceleration of the actuator.

The regenerative resistance of the regenerative absorption circuit incorporates a fuse. When the temperature of the regenerative resistance increases due to excessive regeneration and the fuse is blown, the regenerative circuit no longer works, and the main circuit voltage increases. If the regenerative error occurs immediately the control circuit power is shut down and turned on again, it may be due to a blown fuse. In this case, connect the external regenerative resistance and switch the jumper setting.

For connection of an external regenerative resistance and change of the jumper setting, refer to 3.8.

Operating temperature error

The alarm occurs when the temperature of the HA-680 main unit increases and the temperature sensor trips. To reset the alarm, you must shut down the power and turn it on again after diagnosing the cause.

System error

This alarm occurs when an error of the motor current detection circuit is detected. To reset the alarm, you must shut down the power and turn it on again after diagnosing the cause.

Overcurrent

This alarm occurs when overcurrent is detected by the motor current detection circuit. To reset the alarm, you must shut down the power and turn it on again after diagnosing the cause.

Load short circuit

The alarm occurs when excessive current flows through the FET. To reset the alarm, you must shut down the power and turn it on again after diagnosing the cause.

Memory error

The alarm occurs when read/write fails due to failure of the EEPROM memory of the driver. It can be reset by shutting down the power and turning it on again. However, if the same phenomenon persists, it may be due to a driver failure. Contact one of our branch offices.

Overspeed

The alarm occurs when the rotation speed of the actuator exceeds the motor axis maximum rotation speed +100 rpm for 0.5 s or longer. To clear the alarm, shut off the control power once and turn it on again.

2. I/O ports

The HA-680 drive exchanges signals with the host device via the CN2 connector (26-pin half-pitch connector). This chapter describes the details of the I/O signals.

2.1 Assignment of I/O signals

2.1.1 Assignment of input signals

Assignment of the input signals varies depending on the setting value of "11: Input function assignment" in "Parameter" as shown below. For the setting method, refer to Chapter 6 "Parameter setting" and PSF-520 User's Manual.

Position control, input signal assignment parameter

CN2 Pin No.								
Setting value	Servo-ON	FWD inhibit	REV inhibit	Clear	Alarm clear	Deviation clear	Speed limiting	Current limiting
0	7	8	9	–	10	11	–	–
1	7	8	9	10	–	–	11	–
2	7	8	9	10	–	–	–	11
3	7	–	–	–	8	9	10	11

Note: The setting value "0" is the initial setting value.

Speed control, input signal assignment parameter

CN2 Pin No.							
Setting value	Servo-ON	FWD enable	REV enable	Alarm clear	External/internal command	Speed limiting	Current limiting
0	7	8	9	10	–	11	–
1	7	8	9	10	–	–	11
2	7	8	9	–	–	10	11
3	7	8	9	10	11	–	–
4	7	8	9	–	10	11	–
5	7	8	9	–	10	–	11

Note: The setting value "0" is the initial setting value.

Torque control, input signal assignment parameter

CN2 Pin No.						
Setting value	Servo-ON	FWD enable	REV enable	Alarm clear	External/internal command	Current limiting
0	7	8	9	10	–	11
1	7	8	9	10	11	–
2	7	8	9	–	10	11

Note: The setting value "0" is the initial setting value.

2.1.2 Assignment of output signals

Assignment of the output signals varies depending on the setting value of "12: Output function assignment" in "Parameter" as shown below. For the setting method, refer to Chapter 6 "Parameter setting."

Position control, output signal assignment parameter

CN2 pin no.						
Setting value	In-position ready	Alarm	Operation ready	Limiting speed	Limiting current	Phase Z OC output
0	1	2	3	4	—	5
1	1	2	3	—	4	5
2	1	2	—	3	4	5

Note: The setting value "0" is the initial setting value.

Speed control, output signal assignment parameter

CN2 pin no.						
Setting value	Attained speed	Alarm	Operation ready	Limiting speed	Limiting current	Phase Z OC output
0	1	2	3	4	—	5
1	1	2	3	—	4	5
2	1	2	—	3	4	5

Note: The setting value "0" is the initial setting value.

Torque control, output signal assignment parameter

CN2 pin no.					
Setting value	Attained speed	Alarm	Operation ready	Limiting current	Phase Z OC output
0	1	2	3	4	5

2.1.3 Type of I/O signal connector CN2

The models of the CN2 connector is as follows:

Distributor: 3M
Type: Mini D Ribbon
Connector: 10126-3000PE
Cover: 10326-52F0-008

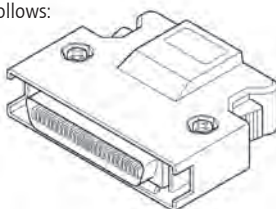

2.2 Position control

2.2.1 I/O port layout

The I/O port layout is shown as follows:

Pin	Signal name	Symbol	I/O
1	Output 1 (in-position ready)	IN-POS	Output
2	Output 2 (alarm output)	ALARM	Output
3	Output 3 (operation ready)	—	Output
4	Output 4 (speed limit)	—	Output
5	Output 5 (phase Z OC output)	Z	Output
6	Output signal common	OUT-COM	Output
7	Input 1 (servo-ON)	S-ON	Input
8	Input 2 (FWD-Inh.)	—	Input
9	Input 3 (REV-Inh.)	—	Input
10	Input 4 (alarm clear)	—	Input
11	Input 5	—	Input
12	Input signal common	IN-COM	Input
13	Encoder Monitor ground	MON-GND	Output

Pin	Signal name	Symbol	I/O
14	FWD pulse+	FWD+	Input
15	FWD pulse-	FWD-	Input
16	REV pulse+	REV+	Input
17	REV pulse-	REV-	Input
18	+24V	+24V	Input
19	—	—	—
20	—	—	—
21	Phase A output +(LD)	A+	Output
22	Phase A output -(LD)	A-	Output
23	Phase B output +(LD)	B+	Output
24	Phase B output -(LD)	B-	Output
25	Phase Z output +(LD)	Z+	Output
26	Phase Z output -(LD)	Z-	Output

Note 1: OC: open collector port, LD: line driver port

Note 2: Function assignment can be performed for the input signals other than servo on (8 to 11 pin) and the output signals of Outputs 3 and 4 (3, 4 pin).

Note 3: Logic changes can be performed for the I/O signals other than output 5 (phase Z OC output) using "13: Input pin logic setting" and "14: Output pin logic setting" in "Parameter."

Note 4: "Pin number 18 +24 V" is not the built-in power supply. The HA-680 drive does not incorporate the internal power supply for pulse input signals. For pulse input signals, an external +24-V power supply must be supplied.



Do not connect the pins with "—" in the signal name column to the external device. If you do, failure may occur because it is connected to the internal circuit.

2.2.2 I/O port connections in the position control

This section describes the connection between the I/O ports and a host controller in position control mode.

Input signal

The HA-680 drive provides five ports for inputs as shown in the figure to the right.

Specifications

Voltage: DC 24 V \pm 10%

Current: 20 mA or less (per port)

Connection

The HA-680 drive does not provide the power supply for the input signals. Connect a [DC 24 V \pm 10%] power supply for the signals to [CN2-12: input signal common].

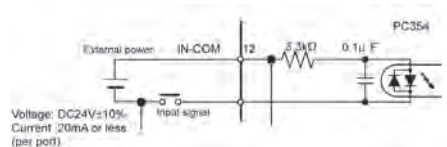
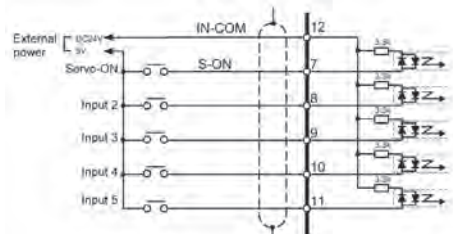

Output signal

The HA-680 drive provides five ports for outputs as shown in the figure to the right.

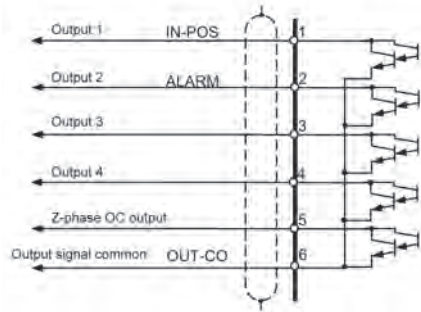

Specifications

- Port: Open collector
- Voltage: DC 24 V or less
- Current: 40 mA or less (per port)
- Every port is insulated by an photocoupler.

Connections

Connect output signals between their respective output ports and [CN2-6: output signal common] port.

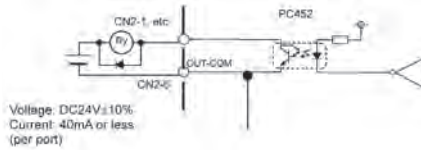

Monitor outputs

The HA-680 drive provides 6 ports of 3 signals for encoder monitoring as shown in the figure to the right.

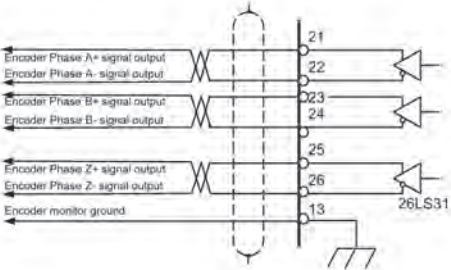

Specifications

The phase A, -B, and -Z signals are transmitted by line drivers (26LS31).

Connections

Receive the signals by line receivers (AM26LS32 or equivalent).

2.2.3 I/O port functions for position control

This section describes the I/O port functions for position control.

CN2-1 In-position: IN-POS (output)

Function

The signal is outputted as in-position ready when the deviation count becomes less than the value of [parameter]→[22: in-position ready range]. The output may be used to confirm in-position ready signal, etc. in a host.

Logic changes can be performed with "14: Output pin logic setting" in "Parameter." With the default value, the output transistor is turned on when the pulse-accumulated amount of the deviation counter is less than the positioning completion range setting value.

Connection

- (1) The figure to the right is a connection example of [CN2-1 in-position ready: IN-POS] port.
- (2) Configure the output circuit for the ports as follows:
 - Supply voltage: +24 VDC or less
 - Signal current: 40 mA or less (per port)

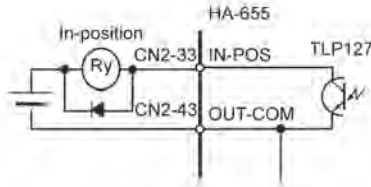

CN2-2 Alarm: ALARM (output)

Function

The output turns OFF when HA-680 drive senses an alarm. The output is [NC contact (b-contact) signal]. Logic changes can be performed with "14: Output

pin logic setting" in "Parameter." With the default value, the transistor is turned on during normal operation, and turned off when an error is detected.

Connection

- (1) The figure to the right is a connection example of the [CN2-2 Alarm: ALARM] port.
- (2) Configure the output circuit for the ports as follows:

Supply voltage: +24 VDC or less
Signal current: 40 mA or less (per port)

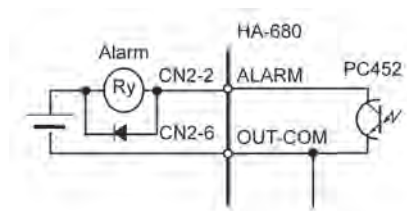

CN2-3 Ready: READY (output)

Function

The output turns ON when the driver becomes ready to drive after initialization, and the driver is ready to communicate with a host.

Note: The signal stays ON even during an alarm.

Logic changes can be performed with "14: Output pin logic setting" in "Parameter." With the default value, the transistor is turned on with the operation ready state.

Connections

- (1) The figure to the right is a connection example of the the [CN2-3 Ready: READY] port.
- (2) Configure the output circuit for the ports as follows:

Supply voltage: +24 VDC or less
Signal current: 40 mA or less (per port)

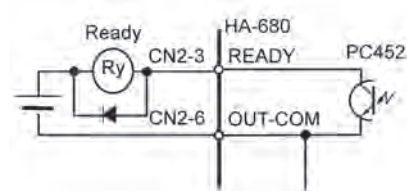

Setting for CN2-3 or 4 Speed limiting: SPD-LMT-M (output)

Function

This is outputted while the speed limit input signal is inputted and the speed is limited to the specified speed.

Logic changes can be performed with "14: Output pin logic setting" in "Parameter." With the default value, the transistor is turned on while the speed is limited.

Connection

- (1) Speed limited to CN2-3: An example of the connections when SPD-LTM-M is set is shown.
- (2) Configure the output circuit for the ports as follows:

Supply voltage: +24 VDC or less
Signal current: 40 mA or less (per port)

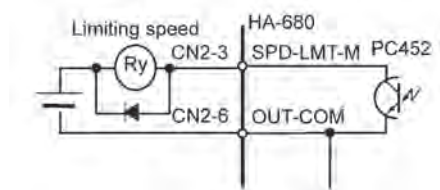

Can be set to CN2-4 current limiting: CUR-LMT-M (output)

Function

This is outputted while the current limit input signal is inputted and the current is limited to the specified current.

Logic change can be performed with "14: Output pin logic setting" in "Parameter."

Connection

- (1) The figure to the right is a connection example of the [CN2-4 Current limiting: CUR-LMT-M] port.
- (2) Configure the output circuit for the ports as follows:

Supply voltage: +24 VDC or less
Signal current: 40 mA or less (per port)

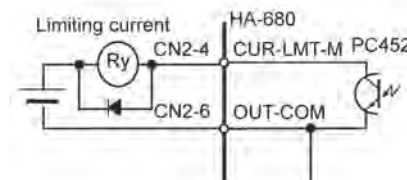

CN2-5 phase Z (OC): Z (output)

Function

The output of the Z pulse of the encoder. The signal is outputted one pulse per motor rotation.

The transistor is turned on during Phase Z output.

Connection

- (1) The figure to the right is a connection example of the [CN2-5 phase Z: Z] port.
- (2) The output signal is insulated by photocouplers. (Response frequency: 10 kHz max)
- (3) Configure the output circuit for the ports as follows:
Supply voltage: +24 VDC or less
Signal current: 40 mA or less (per port)

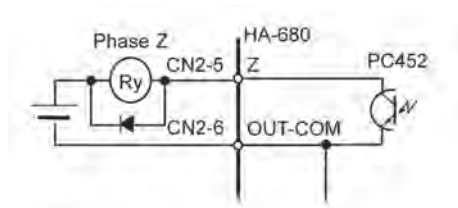

CN2-6 Output signal common: OUT-COM (output signal)

Functions

The common terminal for output signals are CN2-1, 2, 3, 4, and 5

CN2-7 Servo-ON: S-ON (input)

Function

This turns the servo power for the HA-680 drive ON and OFF.

After turning the input ON, the servo power of the HA-680 drive is ON and the actuator can be driven. When OFF, the servo power turns OFF and the motor is free to rotate.

Logic changes can be performed with "13: Input pin logic setting" in "Parameter." With the default value, the servo enable occurs when the input signal is on.

Connection

Connect "NO (a contact) contact signal."
Connect +24 VDC of the input signal external power supply to "CN2-12 Input signal common."

Setting for CN2-8 FWD inhibit: FWD-IH (input)

Setting for CN2-9 REV-inhibit: REV-IH (input)

Function

[FWD inhibit]: Open state (OFF) of the input restricts forward rotation.

[REV inhibit]: Open state (OFF) of the input restricts reverse rotation.

Open states (OFF) of both inputs restricts rotation.

The inputs may be used to limit the motion range of load mechanism between limit sensors.

Logic changes can be performed with "13: Input pin logic setting" in "Parameter." With the default value, the prohibition state can be cleared with the input signal on (close).

Connection

Connect "NC contact (b contact) signal." Connect +24 VDC of the input signal external power supply to "CN2-12 Input signal common."

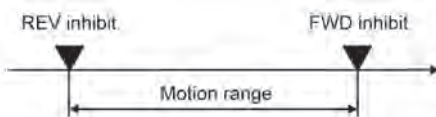

Setting for CN2-10 Clear: CLEAR (input)

Function

- (1) If an alarm exists:
This clears the alarm state, returns to operable state, and clears the deviation count to [0]. For alarms that cannot be cleared, shut off the control power once, and turn it on again.
- (2) If no alarm exists:
This clears the deviation count to [0]. At the same time, this clears the command count and the feedback count. At the same time, the command pulse count is set to the same value as the returned pulse count.

Logic changes can be performed with "13: Input pin logic setting" in "Parameter." With the default value, the clear function works at the edge of the input signal ON.

Connection

Connect "NO (a contact) contact signal." Connect +24 VDC of the input signal external power supply to "CN2-12 Input signal common."

Setting for CN2-8 or 10 alarm clear: ALM-CLR (input)

Function

This signal clears the alarm state and makes it ready for operation. However, the deviation count overflow error becomes the operation ready state when alarm clear: ALM-CLR is inputted after deviation clear: DEV-CLR is inputted.

When an alarm that cannot be cleared occurs, shut down the main circuit power supply and control circuit power supply, remove the cause of the alarm, and then turn on the power again.

Logic changes can be performed with "13: Input pin logic setting" in "Parameter." With the default value, the alarm clear function works at the edge of the input signal ON.

Connection

Connect "NO (a contact) contact signal." Connect +24 VDC of the input signal external power supply to "CN2-12 Input signal common."

Setting for CN2-9 or 11 Deviation clear: DEV-CLR (input)

Function

This signal clears the deviation counter and sets the deviation pulse count to "0." At the same time, the command pulse count is set to the same value as the returned pulse count.

Logic changes can be performed with "13: Input pin logic setting" in "Parameter." With the default value,

the deviation clear function works at the ON edge of the input signal ON.

Connection

Connect "NO (a contact) contact signal." Connect +24 VDC of the input signal external power supply to "CN2-12 Input signal common."

Setting for CN2-10 or 11 Speed limiting: SPD-LMT (input)

Function

This signal limits the speed to the value set in "16: Speed limit" in "Parameter."

If you continue to input a command pulse over the limit speed, the "deviation counter overflow" alarm occurs. This alarm can be cleared by "CN2 Clear: CLEAR" or "CN2 Alarm clear: ALM-CLR." Be careful when you release it because the speed increases instantaneously when the limit is released while the speed is limited.

Logic changes can be performed with "13: Input pin logic setting" in "Parameter." With the default value, the speed limit state occurs when the input signal is on.

Connection

Connect "NO (a contact) contact signal." Connect +24 VDC of the input signal external power supply to "CN2-12 Input signal common."

Setting for CN2-11 Current limiting: CUR-LMT (input)

Function

This signal limits the current below the value set in "17: Forward rotation current limit" and "18: Reverse rotation current limit" in "Parameter."

If you continue to input a command pulse while the current is limited and no acceleration to the speed is possible because the current is limited, the "deviation counter overflow" alarm occurs. This alarm can be cleared by "CN2 Clear: CLEAR" or "CN2 Alarm clear: ALM-CLR." Be careful when you release it because the speed increases instantaneously when the limit is released while the current is limited.

Logic changes can be performed with "13: Input pin logic setting" in "Parameter." With the default value, the current limit state occurs when the input signal is on.

Connection

Connect "NO (a contact) contact signal." Connect +24 VDC of the input signal external power supply to "CN2-12 Input signal common."

CN2-12 Input signal common: IN-COM (input)

Function

The common for all input signals CN2-7, 8, 9, 10, and 11.

Connection

Connect +24 VDC of the input signal external power supply.

CN2-13 Encoder monitor ground: MON-GND (output)

Function

The common for encoder monitor terminals C2-21 to 26.

CN2-14,15 FWD pulse: FWD+, FWD- (input) / CN2-16,17 REV pulse: REV+, REV- (input) CN2-18 +24V :+24 VDC (input)

Function

These ports receive position commands in the position control mode.

Both the line driver input or the open collector input can be used for the commands. For the [open collector] system, both signal voltages of [+24 VDC] and [+5 VDC] are acceptable. The port connections are different.

Note 1: The power supply to the port [CN2-26 +24 V] is the user's responsibility. The HA-655 driver does not have an internal power supply for inputs.

Note 2: Three types of command configurations of [2-pulse], [1-pulse], [2 phase pulse] are available by setting [parameter]→[25: command pulse input configuration]. This has no effect on the connection specifications.

Note 3: The host circuitry for the command pulses should be negative logic circuitry in which a lower voltage (OFF) is used as a logic "1" (active state) and a higher voltage level (ON) is used as a logic "0" (inactive state). In the case of [2-pulse] configuration, the opt-isolator of the no input pulses is OFF state.

Note 4: No command pulse can be accepted during

servo off.

Connection for open collector system

The details of the input ports are shown on the next page.

Specifications of the input ports are as follows:

Specifications of the input ports

- (1) Power voltage:
In case of +24 V: +24 VDC ±10%
In case of +5 V: +5 VDC ±10%
- (2) Signal current: 16 mA (less than 20 mA)



The connection depends on the supply voltage.

The pin numbers to be connected are conditioned by the supply voltage of [+5 V] or [+24 V]. The wrong connection may damage the driver.

Connection for open collector commands and +24 VDC power supply

- Connect FWD command to [CN2-15: FWD-] and [+24 V].
- Connect REV command to [CN2-17: REV-] and [+24 VDC].
- Connect [+24 VDC] of external power supply to [CN2-18: +24 V].
- Plan the command circuit for the ports as follows:
Supply voltage: +24 VDC $\pm 10\%$
Signal current: 16 mA (less than 20 mA)

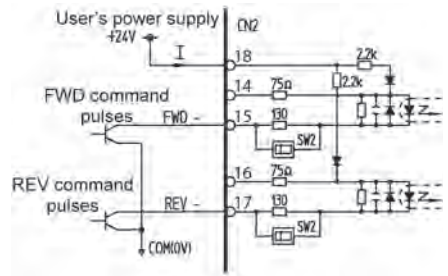

Connection for open collector commands and +5 VDC power supply

- Connect FWD command to [CN2-14: FWD+] and [CN2-15: FWD-].
- Connect REV command to [CN2-16: REV+] and [CN2-17: REV-].
- Open [CN2-18: +24 V].
- Plan the command circuit for the ports as follows:
Supply voltage: +5 VDC $\pm 10\%$
Signal current: 16mA (less than 20 mA)

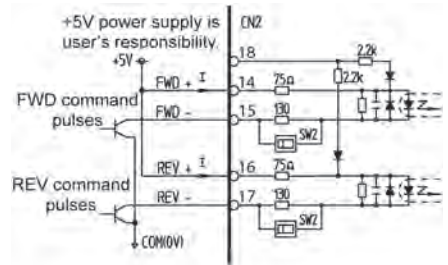

Connections for Line driver systems

- Connect FWD command to [CN2-14: FWD+] and [CN2-15: FWD-].
- Connect REV command to [CN2-16: REV+] and [CN2-17: REV-].
- Open [CN2-18: +24V].

Note: Use line drivers to EIA-422A standard. If you want to use line drivers of other standard, please request technical clearance with us.

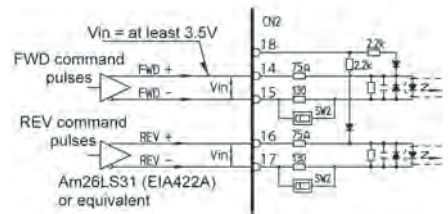

CN2-21 Phase A +(LD): A+ (output) / CN2-22 Phase A -(LD): A- (output)

CN2-23 Phase B +(LD): B+ (output) / CN2-24 Phase B -(LD): B- (output)

CN2-25 Phase Z +(LD): Z+ (output) / CN2-26 Phase Z -(LD): Z- (output)

Function

These ports transmit encoder signals of phase A, -B, -Z through the line driver (26LS31).

Connection

Receive the signals using a line receiver (AM26LS32 or equivalent).

Note: Use EIA-422A standard for the line receiver.

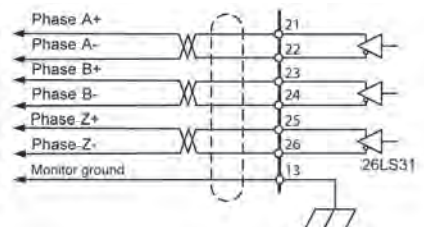

2.2.4 Connection examples for the position control mode

a) Connection example for position control mode with open collector signals

The figure below shows a connection example of position control for open collector signals. The command format is "2 pulse method," and the setting values of "Parameter 11: Input function assignment" and "Parameter 12: Output function assignment" are "0." Note that the encoder connection varies depending on the actuator.

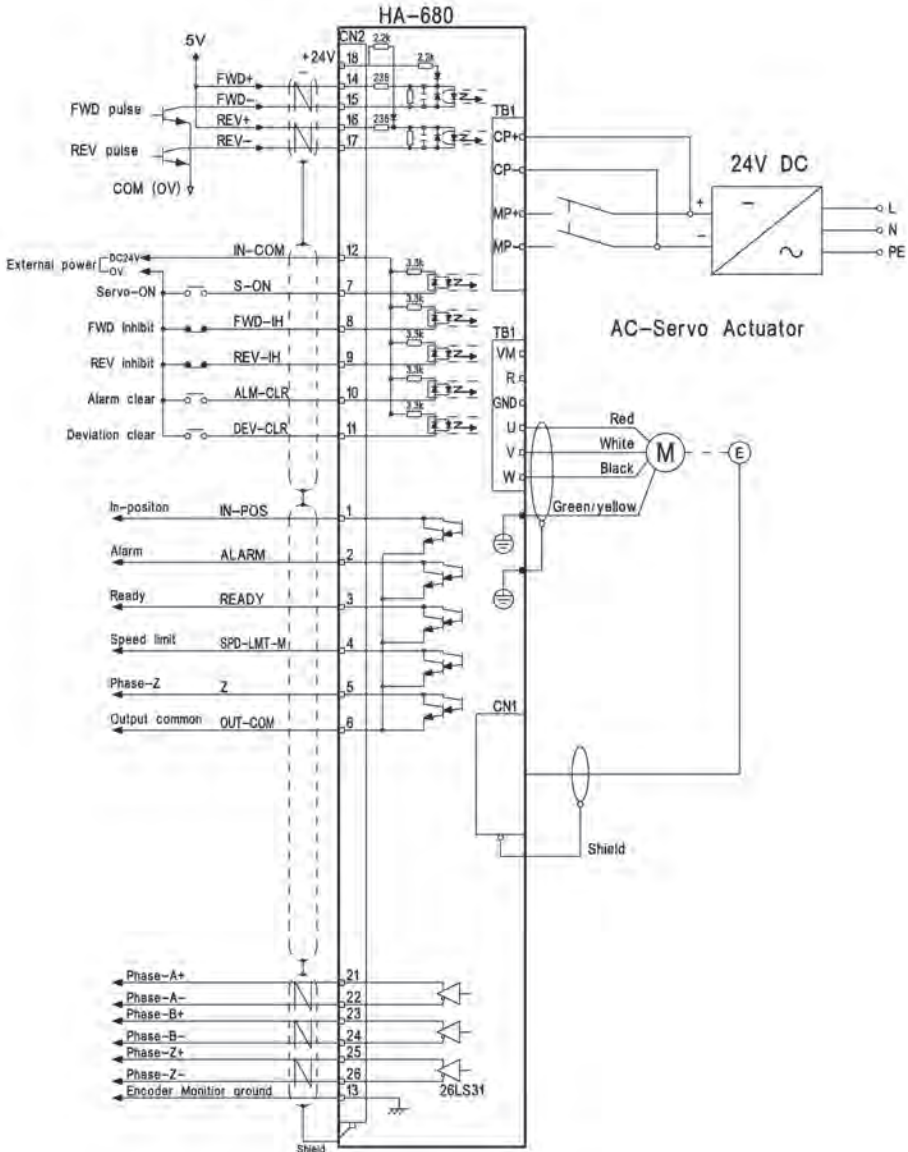

b) Connection example for position control mode with line driver signals

The figure below shows a connection example of position control for open collector signals. The command format is "2 pulse method," and the setting values of "Parameter 11: Input function assignment" and "Parameter 12: Output function assignment" are "0." Note that the encoder connection varies depending on the actuator.

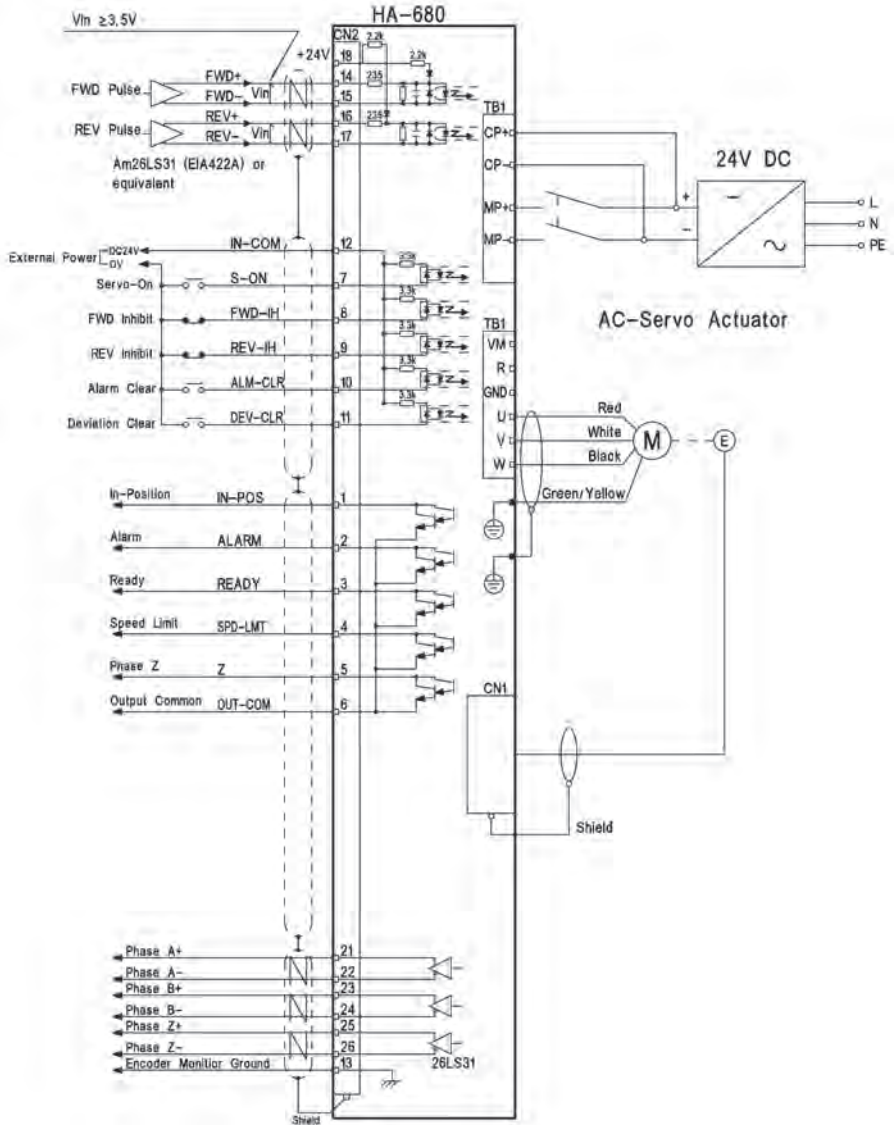

2.3 Speed control

2.3.1 Pin numbers and names of I/O signals

The I/O port layout is as follows:

Pin	Signal name	Symbol	I/O
1	Output 1 (attained speed)	HI-SPD	Output
2	Output 2 (alarm output)	ALARM	Output
3	Output 3 (operation ready)	—	Output
4	Output 4 (limit speed)	—	Output
5	Output 5 (phase Z OC)	Z	Output
6	Output common	OUT-COM	Output
7	Input 1 (servo-on)	S-ON	Input
8	Input 2 (FWD enable)	FWD-EN	Input
9	Input 3 (REV enable)	REV-EN	Input
10	Input 4 (alarm clear)	—	Input
11	Input 5 (speed limit)	—	Input
12	Input signal common	IN-COM	Input
13	Encoder monitor ground	MON-GND	Output

Pin	Signal name	Symbol	I/O
14	—	—	—
15	—	—	—
16	—	—	—
17	—	—	—
18	—	—	—
19	Speed command	SPD-CMD	Input
20	Speed command ground	SPD-GND	Input
21	Phase A+ (LD)	A+	Output
22	Phase A- (LD)	A-	Output
23	Phase B+ (LD)	B+	Output
24	Phase B- (LD)	B-	Output
25	Phase Z+ (LD)	Z+	Output
26	Phase Z- (LD)	Z-	Output

Note 1: OC: Open collector port, LD: Line driver port

Note 2: Function assignment can be performed for inputs 4 and 5 (10, 11 pin) and outputs 3 and 4 (3, 4 pin).

Note 3: Logic changes can be performed for the I/O signals other than output 5 (phase Z OC output) using "13: Input pin logic setting" and "14: Output pin logic setting" in "Parameter."



Do not connect the pins with "-" in the signal column to the external device. If you do, failure may occur because it is connected to the internal circuit.

2.3.2 I/O port connections for speed control

This section describes the connections between the I/O ports and the host for speed control.

Inputs:

The HA-680 drive provides five ports for inputs as shown in the figure to the right.

Specifications

Voltage: DC 24 V $\pm 10\%$

Current: 20 mA or less (per port)

Connections

The HA-680 drive does not provide the power supply for the input signals. Connect a [+24 VDC] power supply for the signals to [CN2-12: Input signal common].

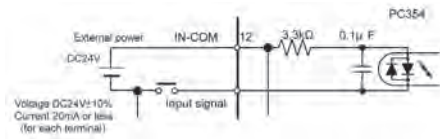
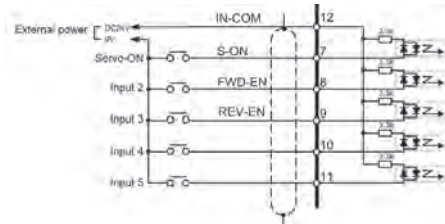

Outputs:

The HA-680 drive provides five ports for outputs as shown in the figure to the right.

Specifications

Voltage: DC 24 V $\pm 10\%$

Current: 40 mA or less (per port)

All ports are insulated by photocouplers.

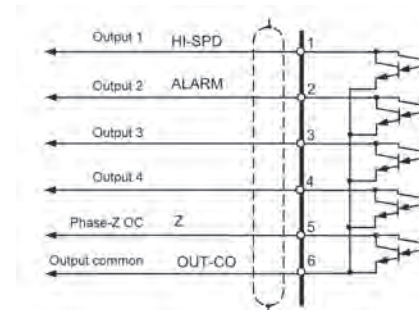

Connections

Connect output signals between their respective output ports and [CN2-6: Output common] port.

Monitor outputs:

The HA-680 drive provides 6 ports of 3 signals for encoder monitoring as shown in the figure to the right.

Specifications

The phase A, -B, and -Z signals are transmitted by the line drivers (26LS31).

Connection

Receive the signals by line receivers (AM26LS32 or equivalent).

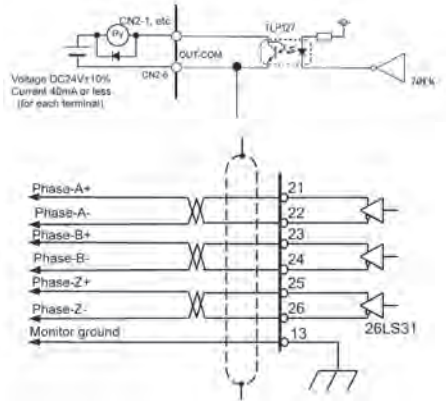

2.3.3 I/O port functions for speed control

This section describes I/O port functions in the speed control.

CN2-1 Attained speed: HI-SPD (output)

Function

The output turns ON when the actuator motor rotates at a speed greater than the value of [parameter]→[31: attained speed].

Logic changes can be performed with "14: Output pin logic setting" in "Parameter." With the default value, the transistor is turned on when the required speed is reached.

Connection

- (1) The figure to the right shows an example of the [CN2-1 attained speed: HI-SPD] port connection.
- (2) Configure the output circuit for the ports as follows:

Supply voltage: DC 24 V or less
Signal current: 40 mA or less (per port)

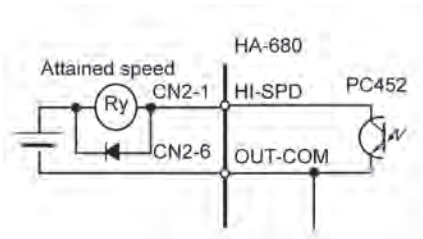

CN2-2 Alarm: ALARM (output)

Function

The output turns OFF when the HA-680 drive senses an alarm. This signal is normally closed (NC, b contact).

Logic changes can be performed with "14: Output pin logic setting" in "Parameter." With the default value, the transistor is turned on during normal operation, and turned off when an error is detected.

Connection

- (1) The figure to the right shows an example of the [CN2-2 Alarm: ALARM] port connection.
- (2) Configure the output circuit for the port as follows:

Supply voltage: DC 24V or less
Signal current: 40 mA or less (per port)

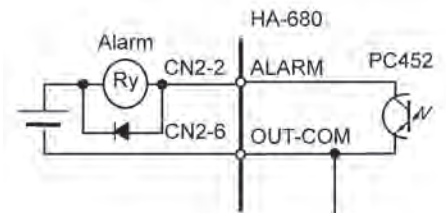

Setting for CN2-3 Ready: READY (output)

Function

The output turns ON when the driver becomes ready to drive after initialization, and the driver can communicate with a host.

Logic changes can be performed with "14: Output pin logic setting" in "Parameter." With the default value, the transistor is turned on in the normal operation ready state.

Note: The output stays ON even in alarm status.

Connection

- (1) The figure to the right shows an example of the [CN2-3 Ready: READY] port connection.
- (2) Configure the output circuit for the port as follows:
Supply voltage: DC 24 V or less
Signal current: 40 mA or less (per port)

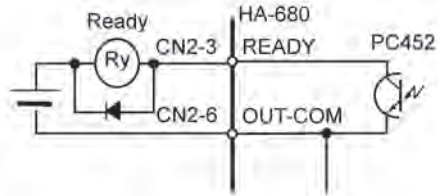

Setting for CN2-3 or 4 speed limiting: SPD-LMT-M (output)

Function

Logic changes can be performed with "14: Output pin logic setting" in "Parameter." With the default value, the transistor is turned on while the speed is limited.

Connection

- (1) The figure to the right shows an example of the [CN2-3 or 4 Speed limiting: SPD-LMT-M] port connection.
- (2) Configure the output circuit for the port as follows:
Supply voltage: DC 24 V or less
Signal current: 40 mA or less (per port)

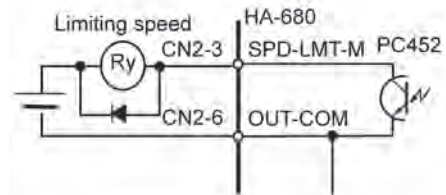

Setting for CN2-4 Current limiting: CUR-LMT-M (output)

Function

The output turns ON for limiting current responding to the [CN2-13 current limit: CUR-LMT] and keeps ON during inputting the signal.

Logic change can be performed with "14: Output pin logic setting" in "Parameter." With the default value, the transistor is turned on while the current is limited.

Connection

- (1) The figure to the right shows an example of the [CN2-4 Current limiting: CUR-LMT-M] port connection.
- (2) Configure the output circuit for the port as follows:
Supply voltage: DC 24 V or less
Signal current: 40 mA or less (per port)

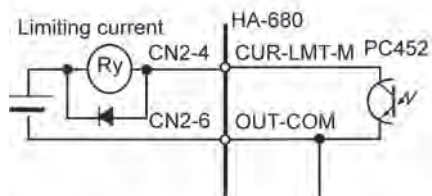

CN2-5 Phase Z (OC): Z (output)

Function

The port outputs the phase Z pulse signals of the encoder. One pulse per motor rotation is sent. The signal may be used with the mechanical origin signal as a precise origin of the driven mechanism.

The transistor is turned on during phase Z output.

Connection

- (1) An example of [CN2-5 phase Z: Z] connection is shown in the figure to the right.
- (2) The port is insulated by photocouplers.
- (3) Configure the output circuit for the ports as follows:
Supply voltage: DC 24 V or less
Signal current: 40 mA or less

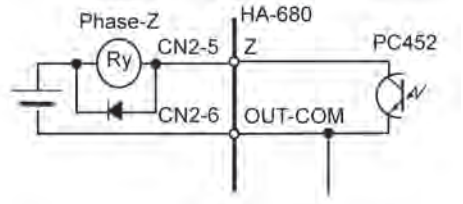

CN2-6 Output common: OUT-COM (output)

Function

This is the common port for the [CN2-1, 2, 3, 4, 5] ports.

CN2-7 Servo-ON: S-ON (input)

Function

This turns the servo power for the HA-680 drive ON and OFF.

After about 100ms from turning the input ON, the servo power of the HA-680 drive is ON and the actuator can be driven. When OFF, the servo power turns OFF and the motor is free to rotate.

Logic changes can be performed with "13: Input pin logic setting" in "Parameter." With the default value, servo power turns ON at normal close.

Connection

Connect [NO-contact signal (a-contact)].
Connect +24 V of the input signal external power supply to "CN2-12 Input signal common."

CN2-8 FWD enable: FWD-EN (input) / CN2-9 REV enable: REV-EN (input)

Function

While the [FWD enable] is [ON] the actuator rotates forward when the [CN2-19 speed command: SPD-CMD] is [+command]. In contrast, the actuator rotates in reverse when the [CN2-19] is [-command]. While the [REV enable] is [ON] the actuator rotates in reverse when the [CN2-19 speed command: SPD-CMD] is [+command]. Conversely, the actuator rotates forward when the [CN2-19] is [-command]. When both signals of [FWD enable] and [REV enable] are [ON] or [OFF], the actuator is holding the

position or zero speed depending on the setting of [parameter]->[38: zero clamp]. Exchanging the signals of [FWD enable] and [REV enable] should be carried out when the actuator stops and the [CN2-7 servo ON: S-ON] is ON state. Otherwise, the actuator may move rapidly falling into dangerous situation. Logic changes can be performed with "13: Input pin logic setting" in "Parameter." With the default value, rotation starts at signal on.

CN2-19 Speed command: SPD-CMD		+ Command		- Command	
CN2-8 FWD enable: FWD-EN		ON	OFF	ON	OFF
CN2-9 REV enable: REV-EN	ON	Zero clamp, zero speed	REV rotation	Zero clamp, zero speed	FWD rotation
	OFF	FWD rotation	Zero clamp, zero speed	REV rotation	Zero clamp, zero speed



The [zero clamp] or [zero speed] function is not available when the conditions below are met. This results in a servo-free (free turning) condition which may result in physical injury e.g. when an unbalanced load is attached to the servo

- (1) No power supply for the main circuit and/or the control circuit
- (2) [OFF] state of [CN2-7 servo-ON: S-ON]
- (3) Occurrence of an alarm
- (4) The parameter "38: Zero clamp" is "0".

Connection

Connect [NO-contact signal (a-contact)]. Connect +24 VDC of the input signal external power supply to "CN2-12 Input signal common."

Setting for CN2-10 Alarm clear: ALM-CLR (input)

Function

This signal clears the alarm state and makes it ready for operation. When an alarm that cannot be cleared occurs, shut down the main circuit power supply and control circuit power supply, remove the cause of the alarm, and then turn on the power again.

Connection

Connect "NO (a contact) contact signal." Connect +24 VDC of the input signal external power supply to "CN2-12 Input signal common." Logic changes can be performed with "13: Input pin logic setting" in "Parameter." With the default value, the alarm is cleared at the edge of the signal ON.

Setting for CN2-10 or 11 external/internal command: CMD-CHG (input)

Functions

This signal switches between the "external command value" from the external device and the "internal command value" set in "32: Internal speed command value" in "Parameter" inside the HA-680 drive. Logic changes can be performed with "13: Input pin logic setting" in "Parameter." With the default value, the operation is as follows.

Open: external command value
Close: internal command value

Connection

Connect +24 VDC of the input signal external power supply to "CN2-12 Input signal common."

Setting for CN2-10 or 11 Speed limit: SPD-LMT (input)

Function

This signal limits the speed for value set in "16: Speed limit" in "Parameter."

Logic changes can be performed with "13: Input pin logic setting" in "Parameter." With the default value, the speed limit state occurs when the input signal is on.

Connection

Connect "NO (a contact) contact signal! Connect +24 VDC of the input signal external power supply to "CN2-12 Input signal common."

Setting for CN2-11 Current limit: CUR-LMT (input)

Function

This signal limits the current to below the value set in "17: Forward rotation current limit" and "18: Reverse rotation current limit" in "Parameter."

Logic changes can be performed with "13: Input pin logic setting" in "Parameter." With the default value, the current limit state occurs when the input signal is on.

Connection

Connect [NO-contact signal (a-contact)]. Connect +24 VDC of the input signal external power supply to "CN2-12 Input signal common."

CN2-12 Input signal common: IN-COM (input)

Function

The common value for input signals CN2-7, 8, 9, 10, and 11.

Connection

Connect +24 VDC of the input signal external power supply.

CN2-13 Encoder Monitor ground: MON-GND (output)

Function

This is the common port for the monitor ports [CN2-21~26].

CN2-19 Speed command: SPD-CMD (input)

Function

Inputs the speed command voltage signal which is obtained by [parameter]→[9: speed conversion factor]. This speed command voltage can be obtained using "30: Speed command input factor" in "Parameter."

The direction of rotation is specified by the polarity (+/-) of the speed command and input signals of [CN2-8 FWD enable: FWD-EN] and [CN2-9 REV enable: REV-EN].

With [FWD enable]: If ON the actuator rotates forward when the [CN2-19 Speed command: SPD-

CMD] is [+]. In contrast, the actuator rotates in reverse when [CN2-19] is [-].

With [REV enable]: If ON the actuator rotates in reverse the [CN2-19 Speed command: SPD-CMD] is [+]. In contrast, the actuator rotates forward when the [CN2-19] is [-].

When both signals [FWD enable] and [REV enable] are ON or OFF, depending on the setting of [parameter]→[38: zero clamp], the actuator is either holding the position (setting:1) or zero speed (setting: 0).

CN2-19 Speed command :SPD-CMD		+ Command		- Command	
CN2-8 FWD enable :FWD-EN		ON	OFF	ON	OFF
CN2-9 REV enable: REV-EN	ON	Zero clamp, zero speed	REV rotation	Zero clamp, zero speed	FWD rotation
	OFF	FWD rotation	Zero clamp, zero speed	REV rotation	Zero clamp, zero speed



Observe the allowable input voltage.

The range of the input voltage is between -10 V and +10 V. Any voltage outside this range may damage the driver.

Connection

Connect the voltage signal to the [CN2-19: speed command: SPD-COM] and the [CN2-20: SPD-GND]. Because the impedance of the analog command input of HA-680 is low, use an output impedance of 1 Kohms or lower.

If the output impedance is too high, there may be a difference in voltage between the command and driver sides. If it is impossible to use impedance below 1 Kohms for reasons of the system, adjust the difference using the parameters "35: Analog command A/D value (Mid)," "36: Analog command A/D value (Max)," and "37: Analog command A/D value (Min)."

Plan the speed command input circuits by referring to the examples below.

Example of external speed command

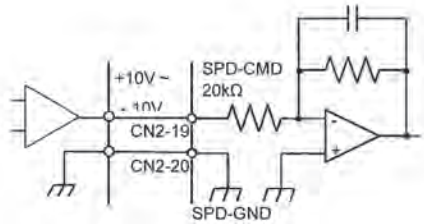
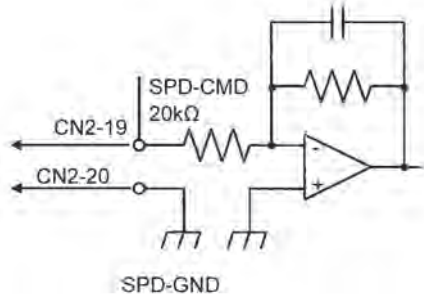

CN2-20 Speed command ground: SPD-GND (input)

Function

The port is the common ground for the [CN2-19 speed command: SPD-CMD].

CN2-21 Phase A +(LD): A+ (output) / CN2-22 Phase A -(LD): A- (output)

CN2-23 Phase B +(LD): B+ (output) / CN2-24 Phase B -(LD): B- (output)

CN2-25 Phase Z +(LD): Z+ (output) / CN2-26 Phase Z -(LD): Z- (output)

Function

These ports transmit encoder signals of Phase A, -B, -Z from the line driver (26LS31).

Connection

Receive the signals using a line receiver (AM26LS32 or equivalent).

Note: Use EIA-422A standard for line receiver.

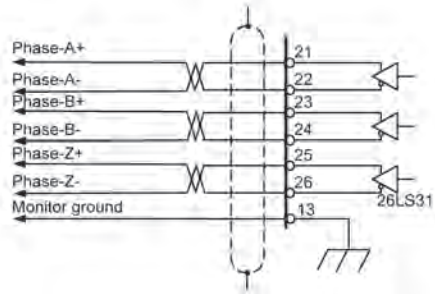

2.3.4 Connection examples in speed control mode

The figure below shows a connection example in speed control for the incremental system. The setting values of "Parameter 11: Input function assignment" and "Parameter 12: Output function assignment" are "0." Note that the connection example varies depending on the actuator.

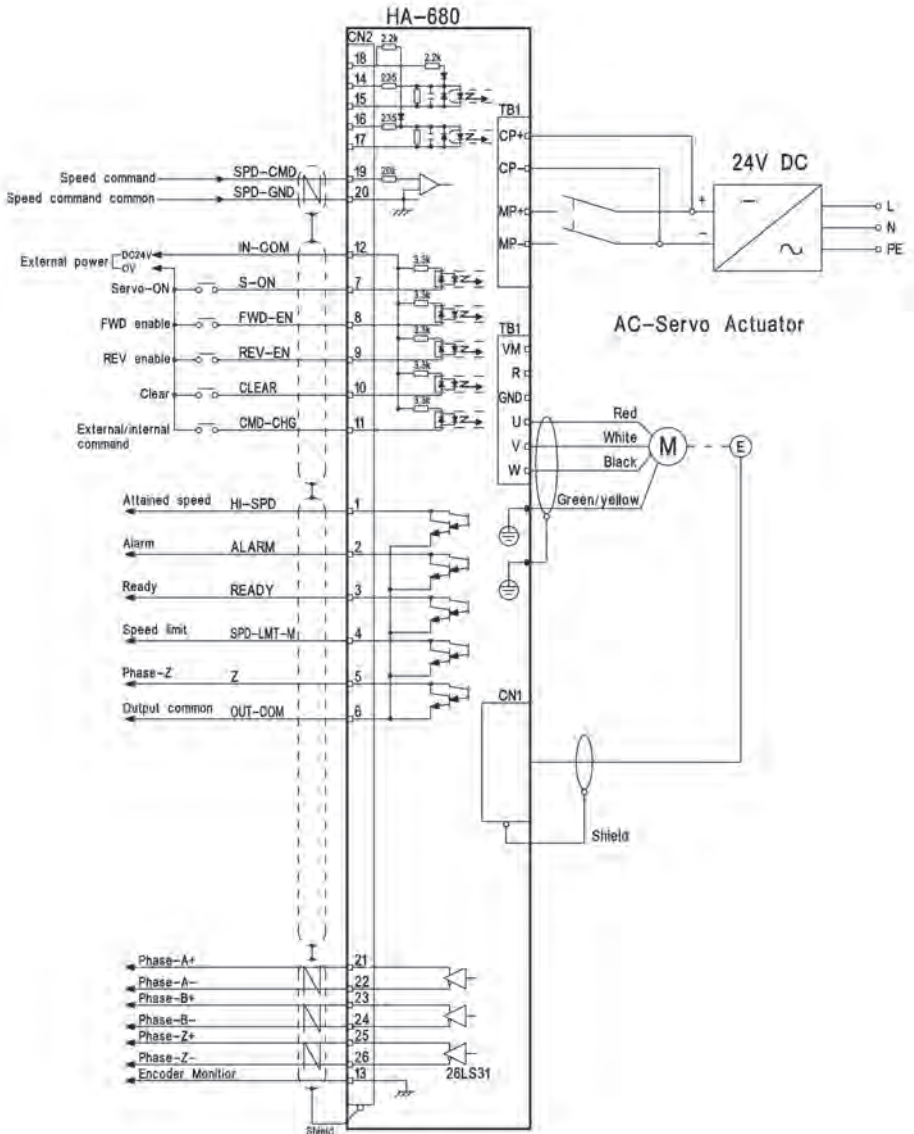

2.4 Torque control

2.4.1 Pin numbers and names of I/O signals

The pin numbers and their names for torque control are as shown in the table below.

Pin	Signal name	Symbol	I/O
1	Output 1 (attained speed)	HI-SPD	Output
2	Output 2 (alarm output)	ALARM	Output
3	Output 3 (operation ready)	READY	Output
4	Output 4 (current limit)	CUR-LMT-M	Output
5	Output 5 (phase Z OC)	Z	Output
6	Output common	OUT-COM	Output
7	Input 1 (servo-on)	S-ON	Input
8	Input 2 (FWD enable)	FWD-EN	Input
9	Input 3 (REV enable)	REV-EN	Input
10	Input 4	—	Input
11	Input 5	—	Input
12	Input signal common	IN-COM	Input
13	Encoder monitor ground	MON-GND	Output

Pin	Signal name	Symbol	I/O
14	—	—	—
15	—	—	—
16	—	—	—
17	—	—	—
18	—	—	—
19	Torque command	TRQ-CMD	Input
20	Torque command ground	TRQ-GND	Input
21	Phase A+ (LD)	A+	Output
22	Phase A- (LD)	A-	Output
23	Phase B+ (LD)	B+	Output
24	Phase B- (LD)	B-	Output
25	Phase Z+ (LD)	Z+	Output
26	Phase Z- (LD)	Z-	Output

Note 1: OC: open collector port, LD: Line driver port

Note 2: Function assignment can be performed for inputs 4 and 5 (10, 11 pin).

Note 3: Logic changes can be performed for the I/O signals other than output 5 (phase Z OC output) using "13: Input pin logic setting" and "14: Output pin logic setting" in "Parameter."



Do not connect the pins with "-" in the signal column to the external device. If you do, failure may occur because it is connected to the internal circuit.

2.4.2 I/O port connections in torque control mode

This section describes the connection between the I/O ports and a host in torque control.

Inputs:

The HA-680 drive provides five ports for inputs as shown in the figure to the right.

Specifications

Voltage: DC 24 V ±10%

Current: 20 mA or less (per port)

Connection

The HA-680 drive does not provide the power supply for input signals. Connect a [+24 V] power supply for the signals to [CN2-1: input signal common].

Outputs:

The HA-680 drive provides five ports for outputs as shown in the figure to the right.

Specifications

Voltage: DC 24 V ±10%

Current: 40 mA or less (per port)

All ports are insulated by photocouplers.

Connection

Connect output signals between their respective output ports and [CN2-6: output common] port.

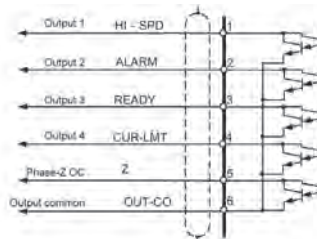
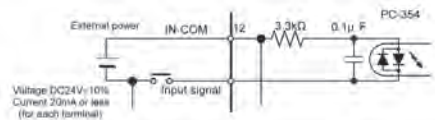
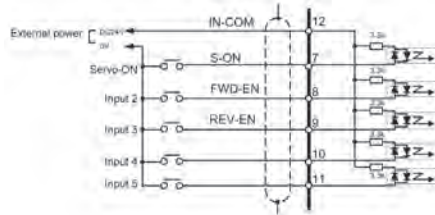

Monitor outputs:

The HA-680 drive provides 6 ports for 3 signals for encoder monitoring as shown in the figure to the right.

Specifications

The phase A, -B, and -Z signals are transmitted by line drivers (26LS31).

Connection

Receive the signals by line receivers (AM26LS32 or equivalent).

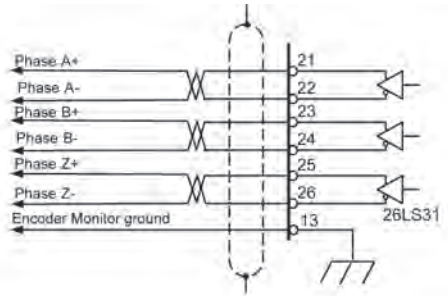

2.4.3 I/O port functions in torque control mode

This section describes I/O port functions in torque control mode.

CN2-1 Attained speed: HI-SPD (output)

Function

The output turns ON when the motor actuator rotates at a speed greater than the value of [parameter]→[31: attained speed].

Logic changes can be performed with "14: Output pin logic setting" in "Parameter." With the default value, the output transistor is turned on when the speed is attained.

Connection

(1) The figure to the right shows an example of the [CN2-1 attained speed: HI-SPD] port connection.

(2) Configure the output circuit for the ports as follows:

Supply voltage: DC 24 V or less

Signal current: 40 mA or less (per port)

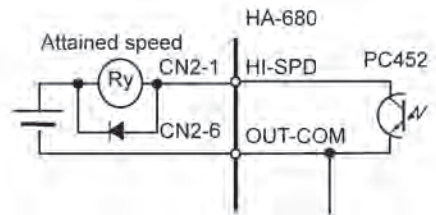

CN2-2 Alarm: ALARM (output)

Function

The output turns OFF when the HA-680 drive-senses an alarm. This signal is normal closed (NC, b contact).

Logic changes can be performed with "14: Output pin logic setting" in "Parameter." With the default value, the transistor is turned on during normal operation, and turned off when an error is detected.

Connection

(1) The figure to the right shows an example of the [CN2-2 Alarm: ALARM] port connection.

(2) Configure the output circuit for the port as follows:

Supply voltage: DC 24 V or less

Signal current: 40 mA or less (per port)

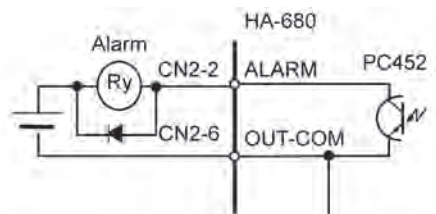

CN2-3 Ready: READY (output)

Function

The output turns ON when the driver becomes ready to drive after initialization, and the driver can communicate with a host.

Logic changes can be performed with "14: Output pin logic setting" in "Parameter." With the default value, the transistor is turned on during normal operation.

Note: The output stays ON even in alarm status.

Connection

- (1) The figure to the right shows an example of the [CN2-3 Ready: READY] port connection.
- (2) Configure the output circuit for the port as follows:
Supply voltage: DC 24 V or less
Signal current: 40 mA or less (per port)

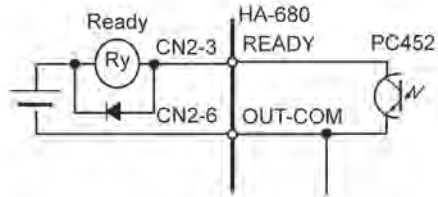

CN2-4 Current limiting: CUR-LMT-M (output)

Function

This is outputted while the current limit input signal is active and the current is limited to the specified current.

Logic changes can be performed with "14: Output pin logic setting" in "Parameter." With the default value, the transistor is turned on during the current limiting.

Connection

- (1) The figure to the right shows an example of the [CN2-4 Current limiting: CUR-LMT-M] port connection.
- (2) Configure the output circuit for the port as follows:
Supply voltage: DC 24 V or less
Signal current: 40 mA or less (per port)

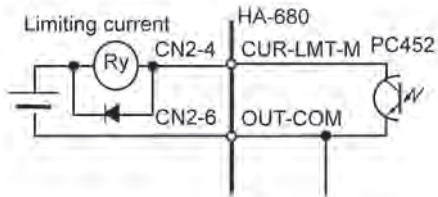

CN2-5 Phase Z (OC): Z (output)

Function

The port output of the encoder Z pulse. The signal is outputted one pulse per motor rotation.

The transistor is turned on during Phase Z output.

Connection

- (1) An example of [CN2-5 phase Z: Z] connection is shown in the figure to the right.
- (2) The port is insulated by photocouplers. (response frequency: 10 kHz max)
- (3) Configure the output circuit of the ports as follows:
Supply voltage: DC 24 V or less
Signal current: 40 mA or less

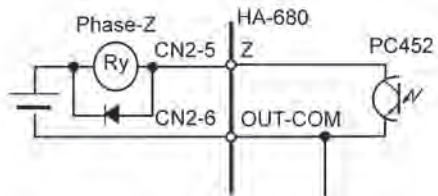

CN2-6 Output common: OUT-COM (output)

Function

This is the common port for the [CN2-1, 2, 3, 4, 5] ports.

CN2-7 Servo-ON: S-ON (input)

Function

This turns the servo power for the HA-680 drive ON and OFF. About 100ms after the INPUT turns ON, the servo power of the HA-680 drive is ON and the actuator can be driven. When OFF, the servo power turns OFF and the motor is free to rotate.

Logic changes can be performed with "14: Output pin logic setting" in "Parameter." With the default value,

the servo ON state occurs when the input signal is on.

Connection

Connect [NO-contact signal (a-contact)].

Connect +24 VDC of the input signal external power supply to "CN2-12 Input signal common."

CN2-8 FWD enable: FWD-EN (input)

CN2-9 REV enable: REV-EN (input)

Function

While the [FWD enable] is [ON] the actuator rotates forward when the [CN2-19 Torque command: TRQ-CMD] is [+command]. In contrast, the actuator rotates in reverse when [CN2-19] is [-command].

While the [REV enable] is [ON] the actuator rotates in reverse when the [CN2-19 Torque command: TRQ-CMD] is [+command]. Conversely, the actuator rotates forward when the [CN2-19] is [-command].

When both signals of [FWD enable] and [REV enable] are [ON] or [OFF], the actuator is holding the position or zero speed depending on the setting of [parameter]→[38: zero clamp].

Exchanging the signals of [FWD enable] and [REV enable] should be carried out when the actuator stops and the [CN2-7 servo ON: S-ON] is ON state. Otherwise, the actuator may move rapidly falling into dangerous situation.

Logic changes can be performed with "13: Input pin logic setting" in "Parameter." With the default value, rotation starts at signal on.

CN2-19 Torque command : TRQ-CMD		+ Torque command		- Torque command	
CN2-8 FWD enable : FWD-EN		ON	OFF	ON	OFF
CN2-9 REV enable: REV-EN	ON	Torque zero	REV rotation	Torque zero	FWD rotation
	OFF	FWD rotation	Torque zero	REV rotation	Torque zero

Connection

Connect [NO-contact signal (a-contact)]. Connect +24 VDC of the input signal external power supply to "CN2-12 Input signal common."

Setting for CN2-10 alarm clear: ALM-CLR (input)

Function

This signal clears the alarm state and makes it ready for operation. When an alarm that cannot be cleared occurs, shut down the main circuit power supply and control circuit power supply, remove the cause of the alarm, and then turn on the power again.

Logic changes can be performed with "13: Input pin

logic setting" in "Parameter." With the default value, the alarm clear function works at the edge of the input signal ON.

Connection

Connect [NO-contact signal (a-contact)]. Connect +24 VDC of the input signal external power supply to "CN2-12 Input signal common."

Setting for CN2-10 or 11 external/internal common: CMD-CHG (input)

Function

This signal switches between the “external command value” from the external device and the “internal command value” set in “40: Internal torque command value” in “Parameter” inside the HA-680 drive.

Logic changes can be performed with “13: Input pin logic setting” in “Parameter.” With the default value, the operation is as follows.

Open: external command value

Close: internal command value

Connection

Connect +24 VDC of the input signal external power supply to “CN2-12 Input signal common.”

Setting for CN2-11 current limit: CUR-LMT (input)

Function

This signal limits the current below the value set in “17: Forward rotation current limit” and “18: Reverse rotation current limit” in “Parameter.”

Logic changes can be performed with “13: Input pin logic setting” in “Parameter.” With the default value,

the current limit state occurs when the input signal is on.

Connection

Connect [NO-contact signal (a-contact)]. Connect +24 VDC of the input signal external power supply to “CN2-12 Input signal common.”

CN2-12 Input signal common: IN-COM (input)

Function

The common port for input signals CN2-7, 8, 9, 10, and 11. It provides the input signal external power supply.

Connection

Connect +24 VDC of the input signal external power supply.

CN2-13 Monitor ground: GND (output)

Function

This is the common port for the monitor ports [CN2-21~26].

Connection

Make connection as the ground for encoder monitor terminals C2-21 to 26.

CN2-19 Torque command: TRQ-CMD (input)

Function

Input the torque command voltage signal which is obtained by [parameter]→[41: torque command input factor].

$$\text{Motor torque} = \text{Torque command voltage} \times \frac{\text{Torque command input factor}}{10.0\text{V}}$$

The direction of rotation is specified by the polarity (+/-) of the torque command and input signals of [CN2-8 FWD enable: FWD-EN] and [CN2-9 REV enable: REV-EN].

While the [FWD enable]: is ON the actuator rotates forward when the [CN2-19 Torque command: TRQ-CMD] is [+]. In contrast, the actuator rotates in reverse for the [CN2-19] is [-].

While the [REV enable]: is ON the actuator rotates in reverse the [CN2-19 Torque command: TRQ-CMD] is [+]. In contrast, the actuator rotates forward when the [CN2-19] is [-].

When both signals [FWD enable] and [REV enable] are ON or OFF, the motor is free to rotate.

CN2-19 Torque command input	:TRQ-CMD	+ Torque command	- Torque command		
CN2-4 FWD enable	:FWD-EN	ON	OFF	ON	OFF
CN2-5 REV enable: REV-EN	ON	Torque zero	REV rotation	Torque zero	FWD rotation
	OFF	FWD rotation	Torque zero	REV rotation	Torque zero



Observe the allowable input voltage.
The input voltage range is between -10 V and +10 V.
Any voltage outside this range may damage the driver.

Connection

Connect the voltage signal to the [CN2-19: Torque command: TRQ-COM] and the [CN2-20: Torque command ground TRQ-GND].

Because the impedance of the analog command input of HA-680 is low, use an output impedance of 1 Kohms or lower.

If the output impedance is too high, there may be a difference in voltage between the command and driver sides. If it is impossible to use impedance below 1 Kohms for reasons of the system, adjust the difference using the parameters "35: Analog command A/D value (Mid)," "36: Analog command A/D value (Max)," and "37: Analog command A/D value (Min)."

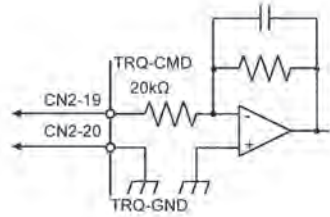

For mor information on how to make adjustment, refer tothe "PSF 520 Software Manual".

Plan the torque command input circuit referring to the examples below.

Example of external torque command

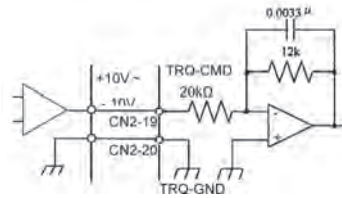

CN2-20 Torque command ground: TRQ-GND (input)

Function

The port is the common ground for the [CN2-19 torque command: TRQ-CMD].

CN2-21 Phase A +(LD): A+ (output) / CN2-22 Phase A -(LD): A- (output)

CN2-23 Phase B +(LD): B+ (output) / CN2-24 Phase B -(LD): B- (output)

CN2-25 Phase Z +(LD): Z+ (output) / CN2-26 Phase Z -(LD): Z- (output)

Function

These ports transmit encoder signals of phase A, -B, -Z from the line driver (26LS31).

Connection

Receive the signals using a line receiver (AM26LS32 or equivalent).

Note: Use EIA-422A standard for line receiver.

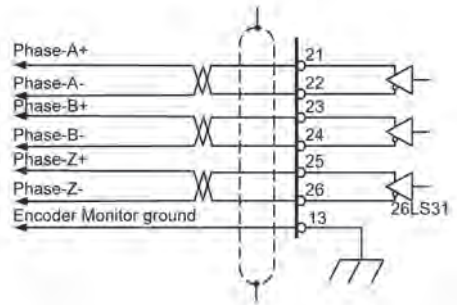

2.4.4 Connection example in torque control mode

The figure below shows a connection example in torque control mode. The values of "Parameter 11: Input function assignment" and "Parameter 12: Output function assignment" are "0." Note that the encoder connection varies depending on the actuator.

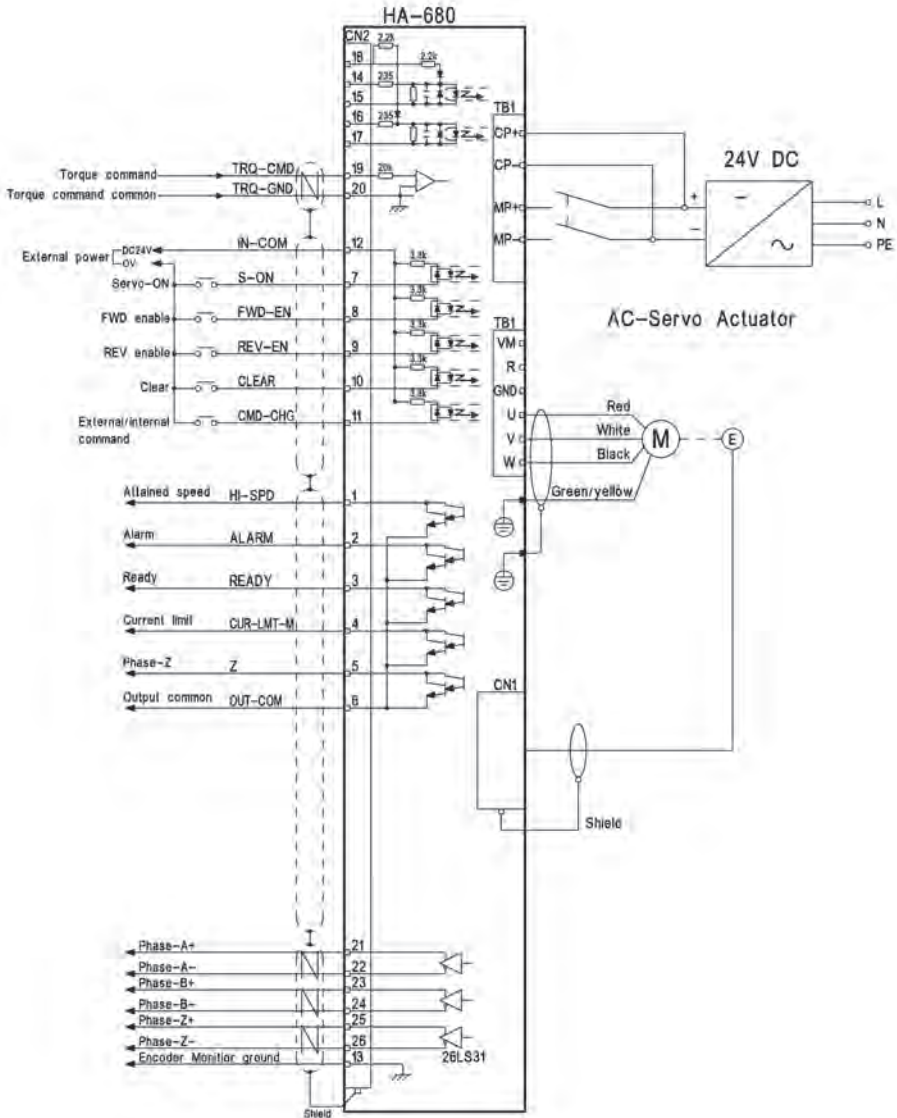

2.4.5 Encoder connection HA-680-CN1

HA-680-CN1		Encoder cable	FHA-xxC-xxx-D200-E
PIN	Signal	not available	Colour
1	+5 V		Red
2	B		Grey
3	Z		Yellow
4	B/		White
5	A		Green
6	Z/		Clear
7	A/		Dark green
8	0V		Black
9	U		Brown
10	U/		Purple
11	V		Blue
12	V/		Light blue
13	W		Orange
14	W/	Pink	

HA-680-CN1		Encoder cable		RSF-3C RSF-5B
PIN	Signal	Colour	EWA-Exx-JST09-3M14	Colour
1	+5 V	white/red		Red
2	B	Red		Green
3	Z	Green		Yellow
4	B/	Blue		
5	A	White		White
6	Z/	Yellow		
7	A/	Black		
8	0V	White/black		Black
9	U	Orange		Brown
10	U/	Grey		
11	V	Purple		Blue
12	V/	Brown		
13	W	Pink		Orange
14	W/	Light blue		

HA-680-CN1		Encoder cable	FHA-xxC-xxx-E200-E
PIN	Signal	EWC-Exx-M06-3M14	Colour
1	+5 V		Red
2			N.c.
3			N.c.
4			N.c.
5	SD +		Yellow
6			N.c.
7	SD -		Blue
8	0 V		Black
9			N.c.
10			N.c.
11			N.c.
12			N.c.
13			N.c.
14		N.c.	

HA-680-CN1		Encoder cable		RSF-8B RSF-11B RSF-14B
PIN	Signal	Colour	EWB-Fxx-M0809-3M14	Colour
1	+5 V	Red (a), red (e)		White
2	B	Yellow (c)		Red
3	Z	Green (d)		Yellow
4	B/	Black (c)		Green
5	A	Blue (b)		Brown
6	Z/	Black (d)		Orange
7	A/	Black (b)		Blue
8	0 V	White (e), black (a)		Black
9	U	Blue (f)		Brown
10	U/	White (f)		Blue
11	V	Yellow (g)		Red
12	V/	White (g)		Green
13	W	Green (h)		Yellow
14	W/	White (h)	Orange	

Numbers in () refers to the cable pairs

2.4.5 Motor connection HA-680-TB1

HA-680-TB1		Motor cable	FHA-xxC-xxx-D200-E
PIN	Signal	not available	Colour
U	U		Red
V	V		White
W	W		Black
PE	PE		Green/yellow

HA-680-TB1		Motor cable	RSF-3C RSF-5B
PIN	Signal	EWA-Mxx-JST04-TN2	Colour
U	U		Red
V	V		White
W	W		Black
PE	PE		Green/yellow

HA-680-TB1		Motor cable	FHA-xxC-xxx-E200-E
PIN	Signal	EWC-MBxx-A06-TN2	Colour
U	U		Red
V	V		White
W	W		Black
PE	PE		Green/yellow

HA-680-TB1		Motor cable	RSF-8B RSF-11B RSF-14B
PIN	Signal	EWC-MBxx-A06-TN2	Colour
U	U		Red
V	V		White
W	W		Black
PE	PE		Green/yellow

3. Installing the HA-680 drive

3.1 Receiving Inspection

Check the followings when products are received.

Inspection procedure

- (1) Check the shipping container and contents for any damage that may have been caused during transportation. If the item is damaged, contact us immediately.
- (2) There is a nameplate attached to the heat sink of the HA-680 drive.
Check whether the item is the one you ordered by looking at the nameplate. If it is different, immediately contact the dealer from whom it was purchased from.

The model code is interpreted as follows:

HA - 6 8 0 - 4 □ - 2 4

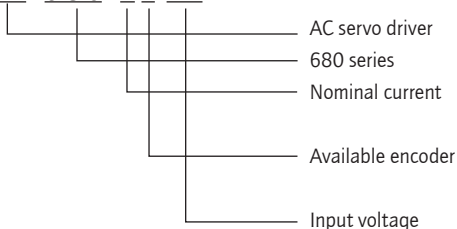



4	4A
6	6A

None	For FHA-Cmini 24 VAC type
B	For RSF series

24	24 VDC
----	--------

- (3) Under the [ADJ.] line, the code of the FHA-C series actuator to be driven by the HA-680 drive is typed. To avoid confusion, group the actuator with its appropriate driver.
- (4) The input voltage for the HA-680 drive is identified with the last code of the model code in the [INPUT VOL.] frame on the label.
24: 24 VDC power supply
If the voltage to be supplied is different from the voltage on the label, immediately contact the dealer whom it was purchased from.

 **Only connect the actuator specified on the driver label.**
The HA-680 drive has been tuned for the actuator specified on the driver label. The wrong combination of HA-680 drive and actuators may cause low torque problems or over current that may cause physical injury and fire.

 **Do not supply a voltage other than the voltage specified on the label.**
The wrong power supply voltage may damage the HA-680 drive resulting in physical injury and fire.

3.2 Handling

The HA-680 drive are electronic devices. Handle them with care and take the following precautions:



- (1) Do not drop screws, solder balls, wire chips, or any other foreign objects into the inside of the HA-680 drive. Failure to observe this caution may result in electric shock or personal injury.
- (2) Do not insert electric wire, steel wire, or a screwdriver into the inside of the HA-680 drive. Failure to observe this caution may result in electric shock or personal injury.



- (1) Because the cover is made of plastic, do not apply excess force or shock.
- (2) The vibration resistance of the HA-680 drive is 5 m/s^2 (10 to 55Hz). Do not mount or transport the HA-680 drive in a manner where it would be subjected to high levels of vibration.
- (3) Do not put the HA-680 drive in a position from where it can easily fall down.
- (4) Do not place anything on the HA-680 drive. The case of the drive may break.
- (5) The allowable storage temperature is from -20°C to $+85^\circ\text{C}$. Do not expose the HA-680 to sunlight for long periods of time, and do not store it in areas where temperatures are likely to fluctuate greatly.
- (6) The allowable storage relative humidity is less than 95%. Do not store the HA-680 in highly humid places or in areas where temperatures are likely to fluctuate greatly.
- (7) Do not store the HA-680 drive in areas where corrosive gas or particles may be present.

3.3 Location and installation

3.3.1 Environment conditions

The environmental conditions of the location are described below.

Service temperature: 0°C to 50°C

Use the drive in a cabinet. The temperature in the cabinet may be higher than the surrounding temperature because of heat generated by the housed devices and the cabinet's size. Plan the cabinet size, ventilation system, and device locations so that the ambient temperature of the driver is always 50°C or less.

Service humidity: 95% or less relative humidity, without condensation

Make sure that water condensation does not occur due to fluctuating temperatures in the storage area or because of frequent heat-and-cool (run-and-stop) operations.

Vibration: less than 5 m/sec^2 (10 Hz to 55 Hz)

When there is a great deal of vibration near the driver, attach a shock absorber under the base to dampen the vibration.

Impact: The location should be free from impact.

Make sure that the HA-680 is not exposed to dust,

water condensation, metal powder, corrosive gas, water, water drops, or oil mist. Do not install the driver in a corrosive gas environment, because the gas may cause damage to connecting parts (connectors, etc.).

Install the driver in a cabinet.

Do not expose it to direct sunlight.

3.3.2 Installation

Install the driver vertically and allow for wide spaces for sufficient air to flow.

Leave 30 mm or more to walls, 50 mm or more to the floor and 100 mm or more from the ceiling, and adjacent devices as shown the figure below.

When planning the ventilation system for the cabinet, refer to the table below, which lists the power consumption of the HA-680 drive.

Driver	HA-680-4	HA-680-4	HA-680-6	HA-680-4B		HA-680-6B	
Actuator	FHA-8C	FHA-11C	FHA-14C	RSF-3C	RSF-5B/RSF-8B	RSF-11B	RSF-14B
Power consumption	10W	20W	40W	10W	10W	20W	40W

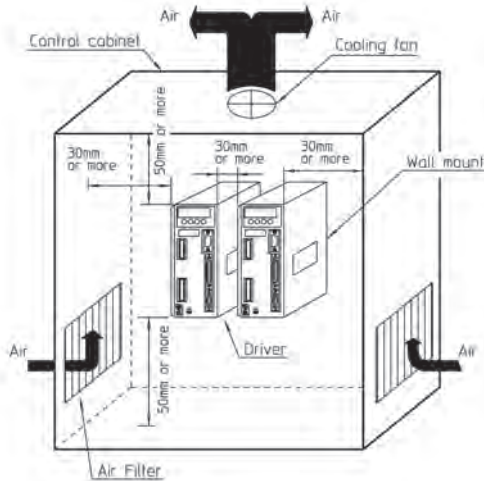

3.3.3 Installing

The HA-680 drive should be mounted on a vertical surface as shown in the figure to the right.

Two mounting holes are provided on the back of the driver. The thickness of the wall should be more than 2 mm.

Procedure

- (1) Screw an 4 mm screw in the lower hole.
- (2) Put the lower mounting hole (slot) of the back of the HA-680 drive on the 4 mm screw.
- (3) Screw tightly through the upper mounting hole with 4 mm screw.
- (4) Tighten the lower 4 mm screw.

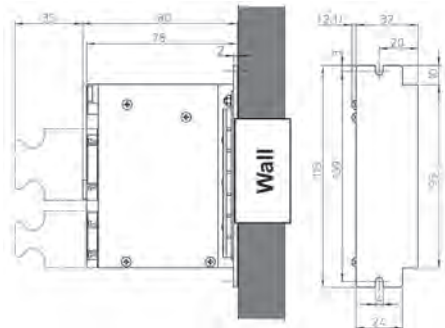

3.4 Suppressing noise

The HA-680 drive employs a FET (power element) with a PWM control for the main circuit. As this element generates switching noise by high-speed power switching, the noise may cause incorrect motion of other equipment or radio noise interference due to poor cabling or poor grounding.

In addition, it is necessary to provide proper cabling in order to suppress incorrect motion of the HA-680 drive by external noise from hosts, which contain electronic components, such as a CPU.

To prevent problems with noise emissions always install cabling and grounding as described below.

3.4.1 Grounding

Refer to the figure below when grounding all devices of the system.

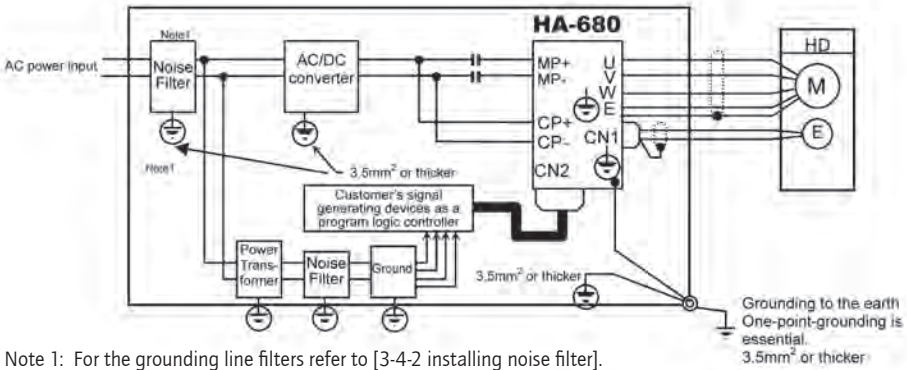

Note 1: For the grounding line filters refer to [3-4-2 installing noise filter].

Grounding motor frame

When actuators are grounded at the driven machine through the motor frame, current flows through the floating capacity (Cf) of the motor from power amplifier of the driver. To avoid influence of the current, always connect the ground terminal (motor frame) of the motor to the ground terminal of the driver, and connect the ground terminal of the driver to the ground directly.

Grounding ducts

When the motor cables are housed in a metal conduit or a metal box, ground their metal parts. The ground should be connected to earth at a single point.

3.4.2 Installing noise filters

Noise filters are recommended to guard against incorrect motion caused by impulse noise that may be emitted from power lines and to suppress noise emissions to the line from the driver.

When more than one driver is used, install noise filters for each driver.

Select bi-directional noise filters that can suppress external and internal noise.

Recommended noise filters are listed in the figure below:

Driver	Model	Manufacturer
All models	SUP-P8H-EPR-4	Okaya electric.

Install the noise filters and the HA-680 drive as near as possible to one another.

Install the noise filters to the cables of the electrical devices other than the HA-680 drive in the same way. Always install noise filters at the source of high fre-

quency noise, such as electric welders and electrical discharge machines.

Incorrect use of noise filters can seriously reduce their effectiveness. Inspect them as per the following instructions:

■ Separate the filtered side and the unfiltered side of the power supply cables from each other. Do not bundle both together. Do not encase them within the same duct.

■ Do not bundle the grounding cable with the filtered side of power cables or signal wires. Do not encase them within the same duct.

■ Avoid daisy-chain wiring of ground cables. Ground them to a frame box or ground plate at a single point

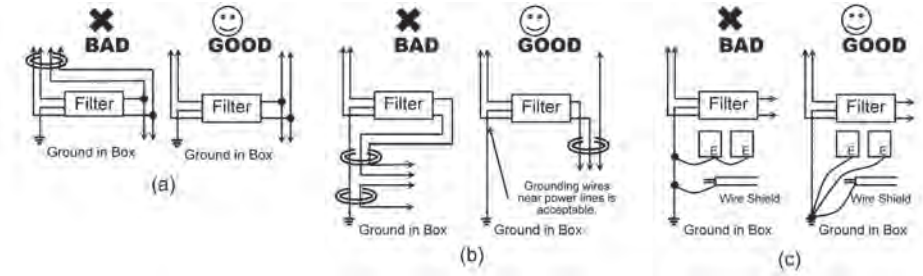

3.4.3 Cabling

In addition to the noise suppression mentioned previously, the following must be observed.

- (1) Use twisted pair cables for I/O signals, and for encoder signals cables. When a host controls several drivers, prepare I/O signal cables for each driver individually.
- (2) Make the length of signal cables as short as possible.
 - (a) I/O signal cable: 3 m or less
 - (b) Encoder signal cable (user's responsibility): 20m or less, providing that the wire conductivity is less than 0.04 ohm/m. Optional cables 3 m/5 m/10 m long are available.
- (3) Install surge protector devices to magnetic relays coils, magnetic switches (conductor), and solenoids.

- (4) Separate power cables (power source cables and motor cables) and I/O signal cables in 30 cm or more. Do not encase both cables in one pipe or duct, and do not bundle them.
- (5) Do not open the end of analog signal cables such as speed signal cables.
- (6) As the HA-680 drive is designed for industrial use, it provides no specific radio interference provisions. Accordingly, line filters should be inserted for the power supply cables in the event that the driver:
 - is used in the vicinity of private residences.
 - causes apparent radio interference.

3.5 Connecting power cables

3.5.1 Instructions for power supply



Before connecting the power cable to the HA-680 drive, turn OFF the electric-ity to avoid electric shock.



- (1) Connect the power cable to the HA-680 drive only after installing the driver on a wall.
- (2) Ground the HA-680 drive, to avoid electric shock, malfunctions caused by external noise, and for the suppression of radio noise sup-pression.

3.5.2 Allowable sizes of cables

The minimum allowable wire sizes for the power ca-bles, ground wires, and other cables are listed below. We recommend wires as thick as possible.

Cable	Symbol	Allowable wire sizes (mm ²)					
		HA-680-4 FHA-8C FHA-11C	HA-680-6 FHA-14C	HA-680-4B RSF-3C RSF-5B		HA-680-6B RSF-11B RSF-14B	
Main Power Supply		MP+,MP-	1.25				
Control Power Supply		CP+,CP-	1.25				
Motor Leads	Note 3	U,V,W,E	0.5	0.75	0.33	0.5	0.75
Ground (FG) line		Ground mark	1.25				
For external resistance / external capacitor		VM,R,GND	1.25				
Encoder Port	Note 3	CN1	0.3mm ² twist pair shielded cable Note 3.				
I/O Signal Port		CN2	0.35mm ² twist pair, or twist pair whole-shielded cable				

Note 1: When bundling wires or enclosing in conduits (plastic or metal pipes), use wire one size larger.

Note 2: In hot environments, such as the temperature in a cabinet, use heat-resistant cable (IV or HIV).

Note 3: We provide the following relay cables (3 m/5 m/10 m) for the motor and encoder. Note that the model varies depend- ing on the actuator used.

Servo drive	Actuator	Motor feedback Input	Motor cable	Brake cable	Encoder cable	
HA-680-4B-24	RSF-3C-xxx-D020-C	8-wire encoder with HALL sensor (Open collector).	EWA-Mxx-JST04-TN2	EWA-Bxx-JST03-TMC	EWA-Exx-JST09-3M14 ¹⁾	
	RSF-5B-xxx-D050-xC					
	RSF-8B-xxx-F100-24A-C		EWC-MBxx-A06-TN2	not available	EWB-Fxx-M0809-3M14 ¹⁾	
HA-680-6B-24	RSF-11B-xxx-F100-24A-C	14-wire encoder with HALL sensor (RS422 line driver)				
	RSF-14B-xxx-F100-24A-C					
HA-680-4-24	FHA-8C-xxx-D200-E				not available	
	FHA-11C-xxx-D200-E					
HA-680-6-24	FHA-14C-xxx-D200-E				not available	
HA-680-4-24	FHA-8C-xxx-E200-CE	4-wire encoder with serial interface	EWC-MBxx-A06-TN2	not available	EWC-Exx-M06-3M14	
	FHA-11C-xxx-E200-CE					
HA-680-6-24	FHA-14C-xxx-E200-CE					

Note 1: The encoder connecting cable includes an electrical circuit to transform the "Open collector" signal into a differential signal. The encoder extension cables are available in the following three versions.

xx =	03	3 m cable length
	05	5 m cable length
	10	10 m cable length

3.5.3 Connecting power cables

The terminal block for the power is located on the front panel of the HA-680 drive.

As shown in the figure to the right, strip the end of the wires of the power supply cable and the motor cable, and connect the wires to each terminal firmly. When working with the connection cables, be careful not to damage the wire.

To prevent malfunction of the HA-680 drive due to external noise, insert the “noise filter” into the power line.

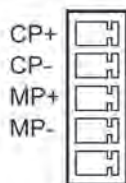
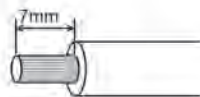
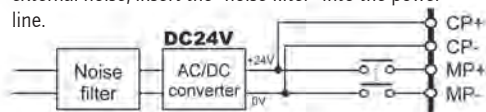

Model:
MC1.5/5-G-3.81
(Phoenix contact)

The HA-680 drive contains a surge-current-suppress-circuit of capacitor type. Although the circuit reduces line voltage fluctuation, avoid daisy-chain wiring of the power lines, and connect units with a main switch.

The HA-680 drive is the DC power input type. Use the power supply with the following power supply capacity.

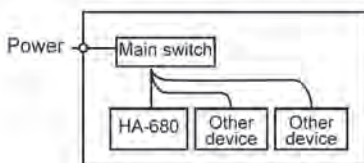

Good cable management

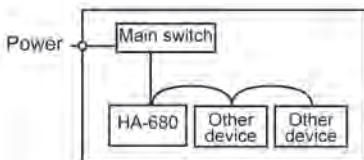

Bad cable management

Drive	Actuator	Power supply capacity (W)	
		Continuous rating	Instantaneous
HA-680-4	FHA-8C / RSF-8	40	120
	FHA-11C	80	240
HA-680-6	FHA-14C / RSF-11 / RSF-14	120	360
HA-680-4B	RSF-3C RSF-5B	20	50



To supply power, use the secondary-side power supply with double insulation from the primary side.

3.6 Connecting the ground wire

Use a wire of the following size or more:

Terminal/connector	Allowable wire sizes (mm ²)
Ground(PE)	1.25

The HA-680 drive is provided with a grounding terminal.

3.7 Connecting the motor and regeneration resistor cables

Connect the motor cable to the [U, V, W] terminals of the HA-680 drive as shown in the figure below. Refer to the phase order of the motor cable in the actuator manual and connect the end terminal of the cables to the driver terminals that have the same symbol.

No alarms are provided for wrong phase order or for open-phases. In addition, refer to "3.5.3 Connecting power cables".

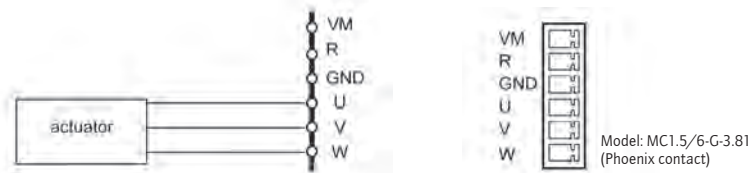

Wrong phase order and connection or disconnection of the motor cable during driving may cause abnormal actuator motion.

3.8 Connecting regenerative absorption resistance / capacitors

HA-680 has a regenerative absorption circuit as standard. The capacity of the regenerative resistance incorporated into the main unit is 2 W. Under the operating conditions in which operation can be performed only with the main unit, set the tact time above the calculation result shown in the table below.

For the RSF supermini series actuators, the regenerative absorption circuit incorporated as standard has sufficient capacity. No external resistance or capacitor is required.

Drive	Actuator	Formula
HA-680-4	FHA-8C / RSF-8B	$0.3 \times \text{Load inertia} + 0.1$ (second)
	FHA-11C	$0.6 \times \text{Load inertia} + 0.5$ (second)
HA-680-6	FHA-14C / RSF-11B / RSF-14B	$1.7 \times \text{Load inertia} + 2.0$ (second)



- If the tact time is shorter than the calculation result, connect an external resistance or external capacitor.
- If the tact time is shorter than the calculation result and no external resistance or external capacitor is connected, the built-in fuse of the regenerative resistance may be blown during operation.
- The built-in fuse must be replaced once blown. As a result, the regenerative circuit stops, causing a regenerative error alarm.
- When the alarm occurs, refer to "7.1 Alarms and diagnostic tips."

Use the following as a guide when selecting the capacity of the external resistance/capacitor to be connected.

(1) If an external capacitor is connected when the load inertia ratio is 2 or less:

Drive	Recommended capacitor mode	Capacity x quantity	Manufacturer
HA-680-4	UPJ1H102MHH	1000 μ F x 1	Nichicon
	UPJ1H222MHH	2200 μ F x 1	
HA-680-6	UPJ1H222MHH	2200 μ F x 4	

Connect it to the VM and GND terminals of the HA-680 drive, as shown below.



(2) If an external resistance is used, or the load inertia ratio is 2 or more: The resistance must be $30 \times \frac{\text{Tact time calculation result}}{\text{Actual tact time}}$ (W) ohms. Use the following formula for the capacity.

Connect it to the R and GND terminals of the HA-680 drive, as shown below.

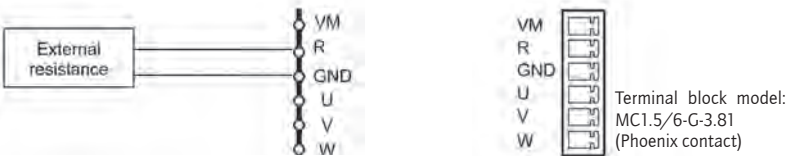

Change the setting of the regenerative resistance internal/external switch terminal of the HA-680 drive, as shown below. The external resistance is not effective unless the setting is changed.

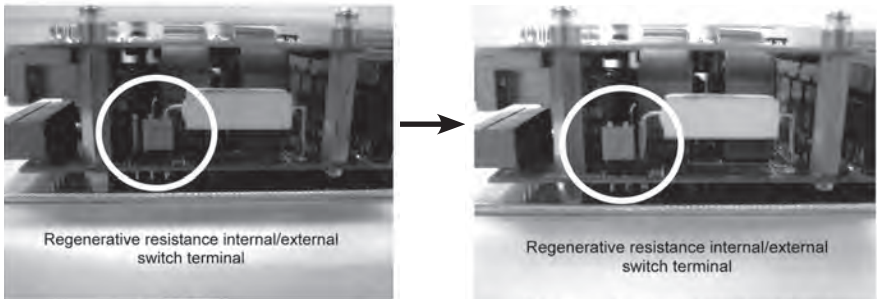

Default setting
(internal regenerative resistance)

When an external resistance is connected

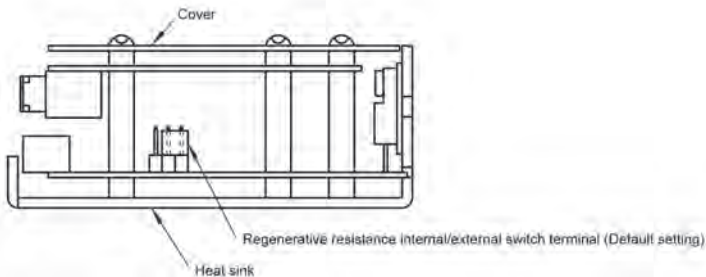

3.9 Connecting cables for the encoder and the I/O

3.9.1 Preparing the encoder cable and the I/O cable

Follow these instructions for the preparation of the encoder cable and the I/O cable.

- (1) Use twisted pair cables for I/O signals, and for encoder signals cables. When a host controls several drivers, prepare I/O signal cables for each driver individually.
- (2) Make the length of the signal cables as short as possible.
 - (a) I/O signal cable: 3m or less
 - (b) Encoder signal cable (user's responsibility): 20 m or less, providing that the wire conductivity is less than 0.04 ohm/m. Cable for 3 m/5 m/10 m are available as an option.
- (3) Separate power cables (power source cables and motor cables) and I/O signal cables by 30 cm or more. Do not encase both cables in one pipe or duct, nor bundle them.
- (4) Do not open the end of analog signal cables as speed signal cables.

Terminals/connectors	Symbol	Allowable wire sizes (mm ²)
Encoder connectors	CN1	0.3 mm ² twist pair shielded cable
External I/O connector	CN2	0.35 mm ² twist pair cable, twist pair whole-shielded cable

3.9.2 Pin layout of the encoder connector (CN1)

Pin layout 1: FHA-C mini 24 VAC type

The models and the pin layout of the encoder connectors are as follows:

Note that pin layout may vary depending on the actuator.

Connector: Model 10114-3000PE Manufacturer: 3M
 Cover: Model 10314-52F0-008 Manufacturer: 3M



Do not use the pins marked "NC" that are already reserved. Wrong usage may cause failure.

Pin layout 2: RSF supermini series + FHA-C mini with 14 wire encoder

The models and the pin layout of the encoder connectors are as follows:

Note that pin layout may vary depending on the actuator.

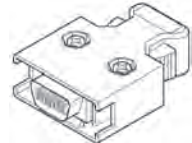
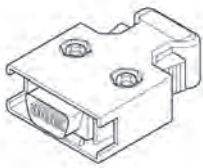

Encoder connector

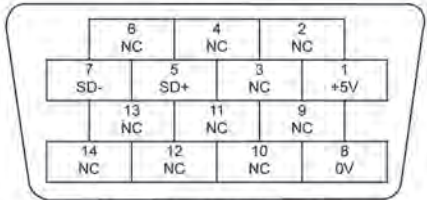

Viewed from soldering side

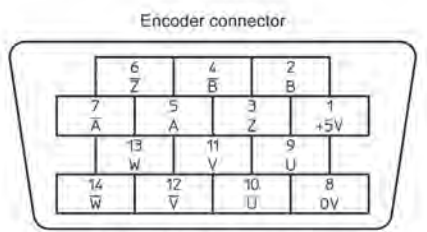

Viewed from soldering side

3.9.3 Pin-layouts of the I/O signal connector (CN2)

The models and the pin layout of the encoder connector are as follows:

Connector: Model 10126-3000PE Manufacturer: 3M
 Cover: Model 10326-52F0-008 Manufacturer: 3M

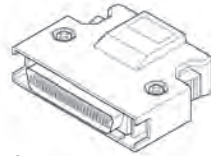

For position control

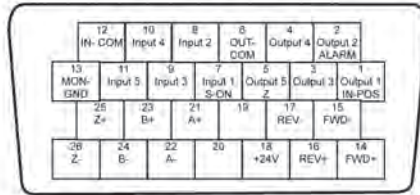

Viewed from soldering side

For speed control

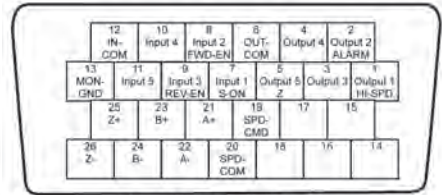

Viewed from soldering side

For torque control

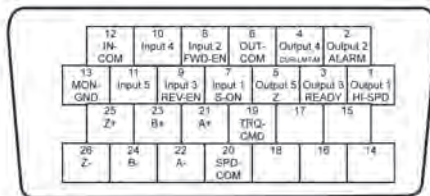

Viewed from soldering side

3.9.4 Connecting cables for the encoder and I/O signals

Firmly connect both connectors of the encoder cable and the I/O signal cable to [CN1] and [CN2] sockets of the HA-680 drive respectively.

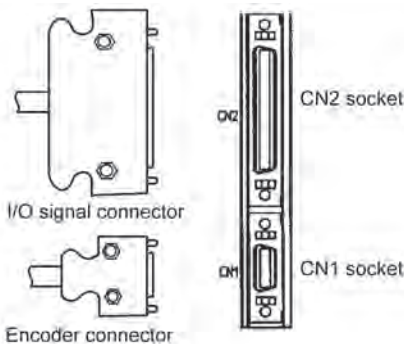

3.9.5 EIA-232C (RS-232C) cable specifications

For EIA-232C (RS-232C), a dedicated cable "HDM-RS232C" (cable length 1.5 m) is provided.

If you provide cables separately, refer to the following specifications:

- (1) Applicable terminal type for cables (driver side)
 Socket terminal: DF11-2428-SCF (Mfg by Hirose)
 Socket: DF11-8DS-2C (Mfg by Hirose)
- (2) Applicable diameter for cables: 0.2 mm² shield line
- (3) Maximum wiring length: within 10 m
 Pin assignments: refer the figure below.

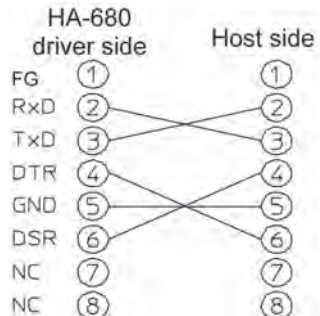

3.10 Power ON and OFF sequences

3.10.1 Power ON / OFF sequence circuit

The following diagram shows the required On and Off sequence of the HA-680 drive.

interval between turning OFF and ON should be more than 30 seconds.

3.10.2 Frequency of power ON / OFF operation

Since the HA-680 drive provides a capacitor as an input filter of the rectifier circuit, large transient current flows at every operation of the main power switch. If the switching is operated too frequently, the resistors for suppressing the transient current may deteriorate.

The switching frequency should not exceed 5 times in an hour and 30 times in a day. Furthermore, the

3.10.3 Power on and off sequences

Program the sequence on the high-level equipment to power the HA-680 drive on and off with the following timings:

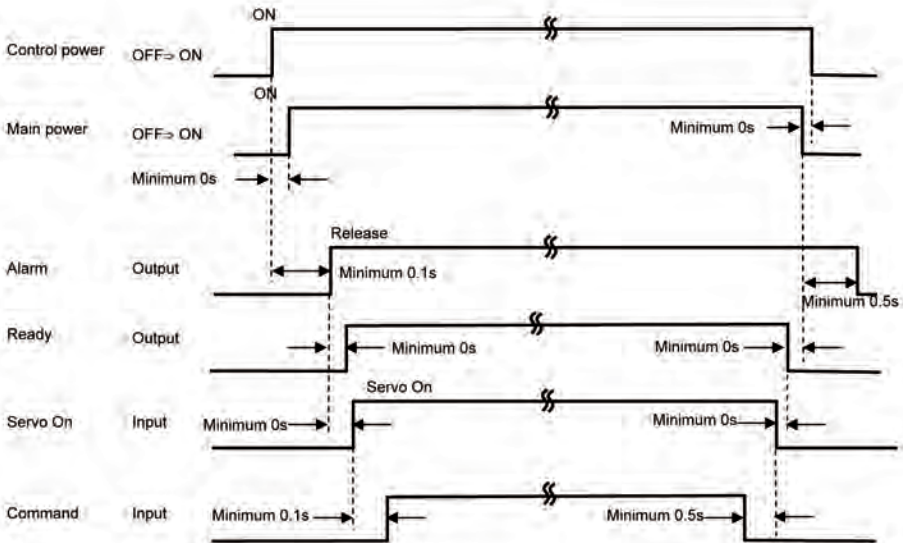

4. Functions of the dedicated communication software PSF-520

The dedicated communication software PSF-520 is for setting and changing parameters for the HA-680.

Note: To set and/or change parameters, dedicated communication software PSF-520 is required.

The overview of the functions of PSF-520 are shown below. For details and operation methods, refer to a separate document, "PSF-520 User's Manual."

- **Status display**

Displays basic information such as the software version of the HA-680 drive.

- **State display**

Displays the operation state such as rotation speed.

- **Parameter setting**

Allows you to set, change, and save parameters.

- **I/O signal monitoring**

Displays the states of the I/O signals.

- **Alarm display**

Displays the current and 8 latest alarms.

- **Waveform monitoring**

Performs waveform measurement of speed, torque, etc. during operation.

- **Command transmission**

Allow you to perform JOG operations.

5. Operations



**When electric power is ON, do not make any wiring changes.
In advance of wiring work, shut off the electrical power supply to be save from electric shock.**



1. Inspect the cabling before turning the power ON and correct poor cabling if necessary.
 - (1) Is the cabling correct?
 - (2) Is there any temporary cabling? Are all wires connected to the terminals?
 - (3) Are there any loose terminal connections?
 - (4) Are the wires grounded properly?
2. Never wire the unit or make changes to the wiring while the power is ON. Turn the power OFF first.
3. Clean around the equipment with the power OFF. Make sure there are no wire chips or tools in the equipment.

5.1 Trial run



1. Complete the trial run before actual operation.
2. Drive the actuator only during the trial run; disconnect the actuator from the driven mechanism or load.

5.1.1 Driving actuator only

Drive the actuator only without load during the trial run.

Reason for the trial run

- (1) Verifying the power cable wiring
- (2) Verifying the motor cable wiring (the servomotor cable and the encoder cable)
- (3) Verifying the I/O signal communication with the host device

Turning an control power

If the actuator code set in the driver and the actuator that is actually connected match:

→ The green LED (power on) of the HA-680 drive illuminates. As a result of auto identification, the actuator code matches.

The next operation is turning the servo power ON. Start with the procedure (3) "Turning on the main circuit power".

If the actuator code set in the driver and the actuator that is actually connected do not match:

→ The green LED of the HA-680 drive blinks. As a result of auto identification, the actuator code does not match.

Turning on main circuit power

- (3) Turn on main circuit power, and transmit [ON] signal to [CN2-7 servo-ON: S-ON].
 - ➔ The red LED of the HA-680 drive illuminates. The drive circuit is turned on, and a current flows through the actuator.
- (4) For the position mode, transmit [ON] signal to [CN2 clear: CLEAR] or CN2 deviation clear: DEV-CLR].
 - ➔ Clear the internal error counter to zero.

After that, operation is performed using communication software PSF-520. For details, refer to a separate document, "PSF-520 User's Manual."

Operating the actuator by JOG operation

- (5) JOG operation can be performed using a host device with the communication software PSF-520 installed. Start up PSF-520.
- (6) Open the Parameter Setting window.
- (7) Specify the operation pattern using "43: JOG operation acceleration/deceleration time constant," "44: JOG operation feed pulse count," "45: JOG operation S-shape selection," and "46: JOG operation speed" in "Parameter."
- (8) Open the Command Transmission window.
- (9) Press the JOG Operation button, and check the operation of the actuator.

5.1.2 Setting parameters

Following trial run of the actuator you can change/set the parameters via the parameter. To set and/or change parameters, dedicated communication software PSF-520 is required.

For details of parameter setting, refer to Chapter 6 "Parameter Setting" and the user's manual of dedicated communication software PSF-520.

Parameter setting

- (10) Open the Parameter Setting window of the dedicated communication software PSF-520.
- (11) Click the "Read from the servo" button to read the parameters.
- (12) Select the parameter you want to change, and enter the value.
- (13) To cancel the changed value to the original setting value, click the "Read from the file" or "Read from the servo" button.
- (14) To update the changed setting value, click the "Write to the servo" button.

Note: Some parameters require turning on the control circuit power again to update the setting values. For details, refer to Chapter 6 "Parameter Setting" and the user's manual of dedicated communication software PSF-520.
- (15) To save the setting value to disk, click the "Write to the file" button.

5.1.3 End of trial run

When above operations are finished, terminate the trial run.

- (16) Shut down the power according to the power shut down sequence as described in 3.10.3.

6. Setting up parameters

All operations such as parameter setting, display, and adjustment can be performed using dedicated communication software PSF-520. This chapter describes

details of the parameters. For information on how to use the software, refer to a separate document, "PSF-520 User's Manual."

6.1 Parameter list

	No.	Parameter name	Setting range
Gain-related	00	Position loop gain	10~9999
	01	Speed loop proportional gain	10~9999
	02	Speed loop integral gain	10~9999
	03	Speed loop derivative gain	0~9999
	04	Speed feed-forward factor	0~9999
	05	Acceleration feed-forward factor	0~9999
	06	Torque command filter	0~9999
	07	Speed step correction	0~9999
	08	Torque step correction	0~9999
	09	Step correction switch range	0~9999
Operation setting general	10	Control mode	0~5
	11	Input function assignment	0~20
	12	Output function assignment	0~20
	13	Input pin logical setting	0~31
	14	Output pin logical setting	0~15
	15	Control input filter time constant	0~99
	16	Speed limiting	0~*1
	17	FWD current limiting	0~*2
	18	REV current limiting	0~*2
	19	Regenerative brake ON/OFF	0,1
	20	Rotary direction	0,1
Position control-related	21	Allowable position deviation	0~32767
	22	In-position ready range	0~9999
	23	Command pulse input factor-numerator	1~999
	24	Command pulse input factor-denominator	1~999
	25	Command pulse input form	0~2
	26	Multiplication at 2-phase input	1,2,4
	27	Servo-on deviation clear	0,1
	28	Angle correction	0,1
	29	Auto gain setting at positioning	0,1
Speed control-related	30	Speed command input factor	1~*1
	31	Attained speed determination value	1~*1
	32	Internal speed command value	0~*1
	33	Acceleration time constant	1~9999
	34	Deceleration time constant	1~9999
	35	Analog command A/D value (Mid)	0~8192
	36	Analog command A/D value (Max)	0~8192
	37	Analog command A/D value (Min)	0~8192
	38	Zero clamp	0,1
	39	Reserved for the system	*3
Torque control-related	40	Internal command input factor	0~*2
	41	Torque command input factor	0~*2
	42	Reserved for the system	*3
JOG-related	43	JOG operation acceleration/deceleration time constant	1~9999
	44	JOG operation feed pulse count	1~9999
	45	JOG operation S-shape selection	0,1
	46	JOG operation speed	0~*1
Communication-related	47	Communication setting	0,1
	48	CAN ID	*3
	49	CAN communication speed	*3

*1: This is the maximum rotation speed of the applicable actuator x reduction ratio.

*2: The setting varies depending on the applicable actuator.

*3: This area is reserved for the system. Do not perform any setting.

6.2 Parameters

00: Position loop gain (position / speed)

Function

This parameter specifies the gain of the position loop. Determine the value based on the frictional torque and rigidity of the machine.

High setting

- ➔ The position error is small, and high tracking performance to commands is obtained. If the setting is too high, the servo system will be unstable and hunting may occur; it should be decreased so that no hunting occurs.

Low setting

- ➔ If the setting is too low, a problem may occur; for example, the tracking performance to commands may be poor, or position precision may not be obtained.

When no hunting occurs and neither overshoot nor undershoot occurs, increase the gain.

For speed control, it is effective only when zero clamp is set ("Parameter" ➔ "38: Zero clamp").

Setting

unit	Lower limit	Upper limit	Default
-	10	9999	Note

Note: The actual setting varies with the AC servo actuator model. When changing the value, consider the defaults shown in Section 6.3, "Default parameters" as the standard (guide setting).

01: Speed loop proportional gain (position / speed)

Function

This parameter specifies the proportional gain of the speed loop. Determine the value based on the moment of inertia, the frictional torque, and the rigidity of the machine.

High setting

- ➔ If the setting is too high, the servo system will be unstable, and hunting and overshoot may occur.

Low setting

- ➔ If the setting is too low, the responsiveness and tracking performance will be poor.

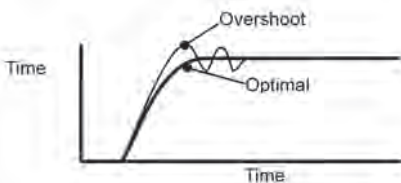

When no hunting occurs and neither overshoot nor undershoot occurs, increase gain.

Setting

Unit	Lower limit	Upper limit	Default
-	10	9999	Note

Note: The actual setting varies with the AC servo actuator model. When changing the value, consider the defaults shown in Section 6.3, "Default parameters" as the standard (guide setting).

02: Speed loop integral gain (position / speed)

Function

This parameter specifies the speed loop integral gain.

High setting

- ➔ If the setting is too high, the servo system will be unstable-, and hunting and overshoot may occur.

Low setting

- ➔ If the setting is too low, the responsiveness and tracking performance will be poor.

Setting

Unit	Lower limit	Upper limit	Default
-	10	9999	note

Note: The actual setting varies with the AC servo actuator model. When changing the value, consider the defaults shown in Section 6.3, "Default parameters" as the standard (guide setting).

03: Speed loop derivative gain (position / speed)

Function

This parameter specifies the speed loop derivative gain.

Usually set this factor to 0.

High setting

- ➔ If the setting is too high, the servo system will be unstable-, and hunting and overshoot may occur.

Setting

Unit	Lower limit	Upper limit	Default
-	0	9999	note

Note: The actual setting varies with the AC servo actuator model. When changing the value, consider the defaults shown in Section 6.3, "Default parameters" as the standard (guide setting).

04: Speed feed-forward factor (position)

Function

This parameter specifies the factor used to give the first-order derivative value to a speed command. Usually set this factor to 0.

This setting is usually required to improve the speed.

Setting

Unit	Lower limit	Upper limit	Default
-	0	9999	0

05: Acceleration feed-forward factor (position)

Function

This parameter specifies the factor used to give the second-order derivative value to a torque command. Usually set this factor to 0.

This setting is usually required to improve the acceleration.

Setting

Unit	Lower limit	Upper limit	Default
-	0	9999	0

06: Torque command filter (position / speed / torque)

Function

For the purpose of suppressing self-excited oscillations within the mechanical system, this parameter specifies the factor for the cutoff frequency of the low pass filter of a torque command.

Usually set this factor to 0.

Setting

Unit	Lower limit	Upper limit	Default
-	0	9999	0

07: Speed step correction (position)**Function**

This parameter specifies the speed command correction amount that is to be added to the speed command, depending on the positive or lower limit is zero amount in the command.

Usually set this parameter to 0. It should be set when the speed is to be improved.

High setting

- ➔ If the setting is too high, the servo system will be unstable, and hunting and overshoot may occur.

Setting

Unit	Lower limit	Upper limit	Default
-	0	9999	0

The setting relates to the one in [09: Step correction switching range] of [Parameter].

08: Torque step correction (position)**Function**

This parameter specifies the torque command correction amount that is to be added to the torque command, depending on the positive or lower limit is zero amount in the command.

Usually set this parameter to 0. It should be set when the speed is to be improved.

High setting

- ➔ If the setting is too high, the servo system will be unstable, and hunting and overshoot may occur.

Setting

Unit	Lower limit	Upper limit	Default
-	0	9999	0

The setting relates to the one in [09: Step correction switching range] of [Parameter].

09: Step correction switch range (position)**Function**

This parameter specifies the amount of position deviation for the deviation counter where the following takes effect: speed step correction ([Parameter] ➔ [07: Speed step correction]) and torque step correction ([Parameter] ➔ [08: Torque step correction]). The values of "Speed step correction" and "Torque step correction" become effective when the amount of position deviation becomes bigger than the set values.

Setting

Unit	Lower limit	Upper limit	Default
Pulse	0	9999	4000

Note: For ordinary use, leave this parameter unchanged from 0.

10: Control mode (The power must be reset after making a change.) (position/speed/torque)**Function**

The HA-680 drive can control the actuator in either the [position control], [speed control] or [torque control]. This function selects an operating mode.

In the position control a command signal is composed of pulse trains, while in the speed mode or torque mode it is composed of an analog voltage.

[0]: position control (factory default) [1]: speed control [2]: torque control

Setting

Unit	Lower limit	Upper limit	Default
-	0	5	0

Note 1: The power must be reset after setting a change. The previous value is effective until you turn on the power again.

Note 2: The upper limit value is 5. However, do not use setting values 3, 4, and 5 because these are reserved for the system.

11: Input function assignment (position/speed/torque)
 (The power must be reset after making a change.)

Function

This function selects the function for the input signal.
 The relationship between the set value and function selection are as follows.

Position control, input signal assignment parameter

CN2 pin no.								
Setting	Servo-ON	FWD inhibit	REV inhibit	Clear	Alarm clear	Deviation clear	Speed limit	Current limit
0	7	8	9	–	10	11	–	–
1	7	8	9	10	–	–	11	–
2	7	8	9	10	–	–	–	11
3	7	–	–	–	8	9	10	11

Speed control, input signal assignment parameter

CN2 pin no.							
Setting	Servo-ON	FWD enable	REV enable	Clear	Internal/ external command	Speed limit	Current limit
0	7	8	9	10	–	11	–
1	7	8	9	10	–	–	11
2	7	8	9	–	–	10	11
3	7	8	9	10	11	–	–
4	7	8	9	–	10	11	–
5	7	8	9	–	10	–	11

Torque control, input signal assignment parameter

CN2 pin no.						
Setting	Servo-ON	FWD enable	REV enable	Clear	Internal/ external command	Current limit
0	7	8	9	10	–	11
1	7	8	9	10	11	–
2	7	8	9	–	10	11

Setting

Unit	Lower limit	Upper limit	Default
-	0	20	0

Note 1: The upper limit value is 20. However, the actual setting range is as shown above depending on the control mode. Do not set any values outside the range because these are reserved for the system.

Note 2: The power must be reset after a change. The previous value is effective until you turn on the power again.

12: Output function assignment (position/speed/torque)
 (The power must be reset after making a change.)

Function

This function selects the function for the output signal. The relationship between the set value and function selection are as follows.

Position control, output signal assignment parameter

CN2 pin no.						
Setting	In-position ready	Alarm	Ready	Limiting speed	Limiting current	Phase Z OC output
0	1	2	3	4	–	5
1	1	2	3	–	4	5
2	1	2	–	3	4	5

Speed control, output signal assignment parameter

CN2 pin no.						
Setting	Attained speed	Alarm	Ready	Limiting speed	Limiting current	Phase Z OC output
0	1	2	3	4	–	5
1	1	2	3	–	4	5
2	1	2	–	3	4	5

Torque control, output signal assignment parameter

CN2 pin no.					
Setting	Attained speed	Alarm	Ready	Limiting current	Phase Z OC output
0	1	2	3	4	5

Setting

Unit	Lower limit	Upper limit	Default
-	0	20	0

Note 1: The upper limit value is 20. However, the actual setting range is as shown above depending on the control mode. Do not set any values outside the range because these are reserved for the system.

Note 2: The power must be reset after a change. The previous value is effective until you turn on the power again.

13: Input pin logical setting (position/speed/torque)
 (The power must be reset after making a change.)

Function

This function sets the logic to enable the functions for the external input signals.

Set the sum of the desired logic values as per the following table.

Example: To enable Input 4 and Input 5 as normal open: $8+16=24$

Therefore, set the value as 24.

Signal	Normal close	Normal open
CN2-7 Input 1 (Servo-ON: S-ON)	0	1
CN2-8 Input 2	0	2
CN2-9 Input 3	0	4
CN2-10 Input 4	0	8
CN2-11 Input 5	0	16

Setting

Unit	Lower limit	Upper limit	Default
-	0	31	0

Note: The power must be reat after a change. The previous value is effective until you turn on the power again.

14: Output pin logical setting (position/speed/torque)
 (The power must be reset after making a change.)

Function

This function sets the logic to determine the function operation state of the external output signals.

Set the sum of the desired logic values in the following table.

Example: To enable Output 3 and Output 4 as normal open: $4+8=12$

Therefore, set the value as 12.

Signal	Normal close	Normal open
CN2-1 Output 1	0	1
CN2-2 Output 2	0	2
CN2-3 Output 3	0	4
CN2-4 Output 4	0	8
CN2-5 Output 5 (Phase Z OC output: Z)	0	—

Setting

Unit	Lower limit	Upper limit	Default
-	0	15	2

Note: The power must be reset after a change. The previous value is effective until you turn on the power again.

Note: Logical setting of Output 5 (phase Z OC output) cannot be performed.

15: Control input filter time constant (position/speed/torque)**Function**

This function sets the time constant for the soft low-pass filter applied to the signals at the control input terminal other than forward rotation/reverse rotation command pulses.

If it is used in an environment where there is external high-frequency noise, set the value so that the control input signal is not easily affected by the noise.

Setting

Unit	Lower limit	Upper limit	Default
ms	0	99	0

16: Speed limiting (position/speed)**Function**

This function sets the motor rotation speed at which the speed limit becomes effective when the speed limit function is assigned to the signal input in the parameter "13: Input pin logical setting."

A value from [1] to [Motor maximum rotation speed] can be entered.

Setting

Unit	Lower limit	Upper limit	Default
r/min	0	Motor maximum rotation speed	Motor maximum rotation speed



This parameter cannot be set for torque control. The upper limit value of the parameter is "motor maximum rotation speed." When the load of the actuator is small (including no load), it may rotate at the maximum rotation speed instantaneously.

17: FWD current limiting (The power must be reset after making a change.)

18: REV current limiting (The power must be reset after making a change.)
(position/speed/torque)

Function

This function sets the current limit value for the forward rotation and reverse rotation sides in the current limit state when the current limit function is assigned to the signal input in the parameter "13: Input pin logical setting."

Set the maximum current values at the forward rotation and reverse rotation sides in percentages of the allowable continuous current.

Setting

Unit	Lower limit	Upper limit	Default
%	0	note 1	note 2

Note 1: The value varies depending on the model of the actuator. The upper limit value is calculated using the following formula based on the values listed in the catalogue and manual of the AC servo actuator. The rated torque is 100%.

Maximum current / Allowable continuous current x 100 (%) = Upper limit value (%)

Note 2: The value varies depending on the model of the actuator. When you change the value, use the "6.3 Default parameter list" as the standard values.

Note 3: The power must be reset after a change. The previous value is effective until you turn on the power again.

19: Regenerative brake ON/OFF (position/speed/torque)

Function

If this parameter is set ON, input of a servo-on signal causes an emergency stop according to the driver control (regenerative brake), and the servo is turned off after it stops.

If this parameter is set OFF, input of a servo-on signal causes the servo to be turned off according to the driver control, and the motor is left free.

0: Does not operate the regenerative brake.

1: Operates the regenerative brake.

Setting

Unit	Lower limit	Upper limit	Default
–	0	1	0

20: Rotary direction (position/speed/torque) (The power must be reset after making a change.)

Function

This function specifies the rotary direction of the actuator when responding to rotary direction commands (FWD or REV) of “Command input signal”.

The relation among them is as follows:

Setting	FWD command	REV command
0	FWD rotation	REV rotation
1	REV rotation	FWD rotation

Setting

Unit	Lower limit	Upper limit	Default
–	0	1	0

Note: The power must be reset after a change.

The previous value is effective until you turn on the power again.

21: Allowable position deviation (position)

Function

The [deviation counter] calculates [deviation count] subtracting the [feedback count] from the [position command]. A large position deviation may result in an error.

When the position error exceeds the [Allowable position deviation], a [max. deviation alarm] occurs and the servo power shuts off.

The relationship between the allowable position deviation, position loop gain, command pulse input factor, and pulse command speed is determined by the following formula in a stationary state. Set an appropriate maximum pulse command value according to the speed.

$$\text{Allowable position deviation} = \frac{\text{Pulse command speed [p/S]}}{\text{Position loop gain}} \times \frac{\text{Command pulse input factor (numerator)}}{\text{Command pulse input factor (denominator)}}$$

Setting

Unit	Lower limit	Upper limit	Default
Pulse	0	32767	30000

22: In-position ready range (position)

Function

When the difference between "command pulse count" and "returned pulse count," which is "deviation pulse count," decreases below the setting value of "in-position ready range," the signal is outputted to "CN2 In-position ready output: IN-POS" as completion of positioning.

This value only monitors the state of position deviation and does not directly affect the rotation control of the servo actuator.

Setting

Unit	Lower limit	Upper limit	Default
Pulse	0	9999	10

23: Command pulse input factor-numerator (The power must be reset after making a change.)
24: Command pulse input factor-denominator (The power must be reset after making a change.)
(position)

Function

This parameter is used with "Command pulse input factor - denominator" as an electronic gear function. It is used to set the relationship between the input pulse number and the amount of moment of the machine that the actuator drives. The relationship should be an integer.

The formula for "numerator and denominator" as follows:

For rotary operation:

$$\text{Angle of movement per input pulse} = \frac{\text{Command pulse input factor - numerator}}{\text{Command pulse input factor - denominator}} \times \frac{360}{* \text{ Actuator resolution}} \times \frac{1}{\text{Reduction ratio of load mechanism}}$$

For linear operation:

$$\text{Amount of feed per input pulse} = \frac{\text{Command pulse input factor - numerator}}{\text{Command pulse input factor - denominator}} \times \frac{\text{Load mechanism feed pitch}}{* \text{ Actuator resolution}}$$

* Actuator resolution = Encoder resolution (4 times) x Actuator duty factor

On the basis of this formula, set the parameter value so that both the numerator and denominator will be integers.

Setting

	Unit	Lower limit	Upper limit	Default
Numerator	-	1	999	1
Denominator	-	1	999	1



Note 1: The power must be reset after a change. The previous value is effective until you turn on the power again.

Note 2: By default, the internal pulse is performed with the encoder resolution (4 times). The amount of movement of the actuator will thus correspond to the encoder resolution (4 times).

25: Command pulse input form (The power must be reset after making a change.)
(position)

Function

Three types of command signals can be inputted to the HA-680 drive as follows:

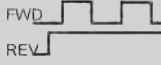
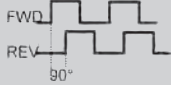
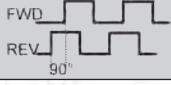
Type	2-pulse train	1-pulse train	2-phase pulse train
Command pulse input form	<p>Forward</p>  <p>Reverse</p> 	<p>Forward</p>  <p>Reverse</p> 	<p>Forward</p>  <p>Reverse</p> 
	FWD CN2-14,15	Forward	Pulse input
REV CN2-16,17	Reverse	Polarity	Phase B
Setting	0	1	2

Setting

Unit	Lower limit	Upper limit	Default
-	0	2	0

Note: The power must be reset after a change. The previous value is effective until you turn on the power again.

26: Multiplication at 4-phase input (The power must be reset after making a change.)
(position)

Function

When [command pulse input form] is set at [2-phase pulse], it is possible to make the motion command pulse count two or four times greater than the command pulse count.

- 1: Same as the command count
- 2: Two times the command count
- 4: Four times the command count

Setting

Unit	Lower limit	Upper limit	Default
-	1	4	4

Note: The power must be reset after a change. The previous value is effective until you turn on the power again.

27: Servo-on deviation clear (position)**Function**

Even when the servo power is OFF, the control power is still ON. If the position of the load mechanism shifts due to gravity or manual force while the servo power is OFF, the deviation count changes. If the servo power is turned ON, the actuator rotates rapidly to make the deviation count return to [0].

This rapid motion may be dangerous. The Servo-ON function allows the deviation count to be reset to [0] when the servo power is turned on. Thus, the actua-

tor will not move when the servo power is restored. However, the position deviation data is lost and the actuator will not return to its original position. Select the input signal at which the deviation counter is cleared.

0: The deviation counter is not cleared when the servo on signal is inputted.

1: The deviation counter is cleared when the servo on signal is inputted.

Setting

Unit	Lower limit	Upper limit	Default
-	0	1	0

Note: When the deviation counter is cleared, the command pulse count becomes the same value as the returned pulse count.

28: Angle correction (The power must be reset after making a change.) (position)**Function**

The HA-680 drive with 4-line specifications provide [angle correction] function, which improves one-way positioning accuracy by compensating it with a pre-analyzed error of the Harmonic Drive® component. The function improves the accuracy about 30%.

0: without angle correction

1: with angle correction

Setting

Unit	Lower limit	Upper limit	Default
-	0	1	0

Note 1: The power must be reset a change. The previous value is effective until you turn on the power again.

Note 2: If no correction data are recorded in the connected actuator, this parameter cannot be set to 1. (0 is read even if it is set to 1.)

* This is not supported by the RSF supermini series actuators.

29: Auto gain setting at positioning (position)**Function**

To get short period for positioning, the function automatically makes speed loop gain higher when a deviation pulse number becomes small.

For the reason that the speed loop gain is proportionate to deviation pulse number, the positioning speed at small error pulse numbers becomes comparatively low. In the case, the positioning response may be improved by the higher speed loop gain.

If the speed loop gain registered in [parameter] →[01: Speed loop proportional gain] is higher than the automatic gain, the speed loop gain has priority.

0: without auto gain setting for positioning

1: with auto gain setting for positioning

Setting

Unit	Lower limit	Upper limit	Default
-	0	1	1

30: Speed command input factor(The power must be reset after making a change.)
(speed)**Function**

This function sets the motor's rotation speed when the input command voltage is 10 V.

The relation between the input voltage and motor rotation speed is determined by the speed command input factor in the following formula.

$$\text{Motor rotation speed} = \text{Input command voltage} \times \frac{\text{Speed command input factor}}{10.0 \text{ V}}$$

Note: The power must be reset after a change. The previous value is effective until you turn on the power again.

Setting

Unit	Lower limit	Upper limit	Default
r/min	1	Motor maximum rotation speed	*

* The value varies depending on the model of the actuator.

Note: Motor rotation speed = Actuator rotation speed x reduction ratio

31: Attained speed determination value

(speed / torque)

Function

This parameter is set at [speed control] or [torque control]. The [CN2 attained speed: HI-SPD] signal is outputted when the actuator speed is more than the value of [attained speed].

Setting

Unit	Lower limit	Upper limit	Default
r/min	1	Motor maximum rotation speed	2000

Note: Motor rotation speed = Actuator rotation speed x reduction ratio

32: Internal speed command

(speed)

Function

This function can operate the actuator without an input signal. This is convenient for test operations without hosts and for system diagnosis.

Actuator motion at the internal speed starts with the input [CN2 external/internal command: CMD-CHG] and stops when the input is OFF.

To reverse an actuator with an [internal speed command], turn [CN2 REV enable: REV-EN] ON.

Setting

Unit	Lower limit	Upper limit	Default
r/min	0	Motor maximum rotation speed	1

Note: Motor rotation speed = Actuator rotation speed x reduction ratio

33: Acceleration time constant (speed)**Function**

This function sets the time for the motor to from 0 r/min to the maximum rotation speed during speed control.

For external speed commands, when a speed command faster than the set value is entered, this set value has higher priority; when a speed command slower than the set value is entered, the speed command has higher priority.

For internal speed commands, acceleration is performed based on the set value.

Note: Motor rotation speed = Actuator rotation speed x Reduction ratio

Setting

Unit	Lower limit	Upper limit	Default
ms	1	9999	1

34: Deceleration time constant (speed)**Function**

This function sets the time for the motor to decelerate from the motor maximum rotation speed to 0 r/min during speed control.

For external speed commands, when a speed command faster than the setting value is entered, this value has higher priority; when a speed command slower than the set value is entered, the speed command has higher priority.

For internal speed commands, deceleration is performed based on the set value.

Note: Motor rotation speed = Actuator rotation speed x reduction ratio

Setting

Unit	Lower limit	Upper limit	Default
ms	1	9999	1

35: Analog command A/D value (mid) (speed / torque)**Function**

This function sets the offset value when the analog command is 0V (a command value to stop the motor).

Enter 0V in the analog command, and set the analog input voltage value in the value monitor of the state display window of communication software PSF-520. For details, refer to a separate document, "PSF-520 User's Manual."

Setting

Unit	Lower limit	Upper limit	Default
-	0	8192	4096

36: Analog command A/D value (max) (speed / torque)**Function**

This function sets the offset value when the analog command is -10V. Enter -10V in the analog command, and set the "analog command A/D value" in the value monitor of the state display window of communication software PSF-520. For details, refer to a separate document, "PSF-520 User's Manual."

Setting

Unit	Lower limit	Upper limit	Default
-	0	8192	8192

37: Analog command A/D value (Min) (speed / torque)**Function**

This function sets the offset value when the analog command is +10 V. Enter +10 V in the analog command, and set the "analog command A/D value" in the value monitor of the state display window of communication software PSF-520. For details, refer to a separate document, "PSF-520 User's Manual."

Setting

Unit	Lower limit	Upper limit	Default
-	0	8192	0

38: Zero clamp (speed)**Function**

During speed control, the motor stops when both FWD enable (FWD-EN) and REV enable (REV-EN) are on or off. When the motor moves due to external force, it stops where it comes to rest because no position control is performed. If zero clamp is enabled, position control is provided so that the motor retains the set position, resisting the external forces.

Setting

Unit	Lower limit	Upper limit	Default
-	0	1	0

0 indicates that it is disabled, and 1 indicates that it is enabled.

39: Reserved for the system

This parameter is reserved for the system. Do not change the setting.

40: Internal torque command input factor (torque)**Function**

"Internal torque command value" allows you to operate the actuator without an input signal. It is useful for a test run of the actuator alone and for system diagnosis. The command value can be set here.

For operation of the actuator using "internal command," internal commands are selected when a signal is entered (on) to "CN2 Internal/external command: CMD-CHG." External commands are selected when the signal is turned off. To rotate the actuator in the reverse direction with this "internal speed command value," turn on "CN2 REV enable: REV-EN."

Setting

Unit	Lower limit	Upper limit	Default
%	0	Note	1

Note: The setting value varies depending on the model of the actuator. The upper limit value is calculated using the following formula based on the values listed in the catalogue and manual of the AC servo actuator.

The allowable continuous torque is 100%.

$$\frac{\text{Maximum current}}{\text{Allowable continuous current}} \times 100 (\%) = \text{Upper limit} (\%)$$

41: Torque command input factor (torque)**Function**

This function sets the output torque when the input command voltage is 10 V.

Note: The value varies depending on the model of the actuator. The upper limit value is calculated using the following formula based on the values listed in the catalogue and manual of the AC servo actuator.
The allowable continuous torque is 100%.

Setting

Unit	Lower limit	Upper limit	Default
%	0	note	note

$$\frac{\text{Maximum current}}{\text{Allowable continuous current}} \times 100 (\%) = \text{upper limit } (\%)$$

$$\text{Output current} = \text{Allowable continuous current} \times \frac{\text{Torque command input factor}}{100} \times \frac{\text{Command voltage factor}}{100}$$

42: Reserved for the system

This parameter is reserved for the system. Do not change the setting.

43: JOG operation acceleration/deceleration time constant (position / speed / torque)**Function**

This function sets the time in which the motor is accelerated from 0 r/min to the maximum rotation speed and the time in which the motor is decelerated from the motor maximum rotation speed to 0 r/min during JOG operation.

Setting

Unit	Lower limit	Upper limit	Default
ms	1	9999	500

44: JOG operation feed pulse count (position)**Function**

When position control is set, it can be moved by the amount set in this parameter.

Setting

Unit	Lower limit	Upper limit	Default
Pulse	1	9999	100

45: JOG operation S-shape selection (position)**Function**

This function allows you to select S-shape acceleration/deceleration during JOG operation.

0: S-shape OFF (linear acceleration/deceleration)

1: S-shape ON (S-shape acceleration/deceleration)

Setting

Unit	Lower limit	Upper limit	Default
-	0	1	0

Note: In other control modes, this parameter is not effective even if it is set.

46: JOG operation speed

(position / speed / torque)

Function

This function sets the motor maximum rotation speed for by JOG commands.

Setting

Unit	Lower limit	Upper limit	Default
r/min	0	Motor maximum rotation speed	500

Remark: Motor rotation speed = tuator rotation speed × ratio

47: Communication setting**Function**

This function selects whether the end code of the communication data is in uppercase or lowercase.

0: Lowercase

1: Uppercase

Setting

Unit	Lower limit	Upper limit	Default
-	0	1	0

This setting does not affect PSF-520 and HA-680. Use the default value without changing it.

48: CAN ID**49: CAN Communication speed**

This parameter is reserved for the system. Do not change the setting.

6.3 Default parameter list

No.	Description	unit	FHA-8C-30	FHA-8C-50	FHA-8C-100
00	Position loop gain	—	40	40	40
01	Speed loop proportional gain	—	75	75	75
02	Speed loop integral gain	—	20	20	20
03	Speed loop derivative gain	—	0	0	0
04	Speed feed-forward factor	—	0	0	0
05	Acceleration feed-forward factor	—	0	0	0
06	Torque command filter	—	0	0	0
07	Speed step correction	—	0	0	0
08	Torque step correction	—	0	0	0
09	Step correction switch range	Pulse	4000	4000	4000
10	Control mode	—	1	1	1
11	Input function assignment	—	0	0	0
12	Output function assignment	—	0	0	0
13	Input pin logical setting	—	0	0	0
14	Output pin logical setting	—	2	2	2
15	Control input filter time constant	ms	0	0	0
16	Speed limit	r/min	6000	6000	6000
17	FWD current limiting	%	188	194	185
18	REV current limiting	%	188	194	185
19	Regenerative brake ON/OFF	—	0	0	0
20	Rotary direction	—	0	0	0
21	Allowable position deviation	Pulse	30000	30000	30000
22	In-position ready range	Pulse	10	10	10
23	Command pulse input factor-numerator	—	1	1	1
24	Command pulse input factor-denominator	—	1	1	1
25	Command pulse input form	—	0	0	0
26	Multiplication at 2-phase input	—	4	4	4
27	Servo-ON deviation clear	—	0	0	0
28	Angle correction	—	0	0	0
29	Auto gain setting at positioning	—	1	1	1
30	Speed command input factor	r/min	6000	6000	6000
31	Attained speed determination value	r/min	2000	2000	2000
32	Internal speed command value	r/min	1	1	1
33	Acceleration time constant	ms	1	1	1
34	Deceleration time constant	ms	1	1	1
35	Analog command A/D value (Mid)	—	3447	3447	3447
36	Analog command A/D value (Max)	—	5984	5984	5984
37	Analog command A/D value (Min)	—	910	910	910
38	Zero clamp	—	0	0	0
39	Reserved for the system	note	0	0	0
40	Internal command input factor	%	1	1	1
41	Torque command input factor	—	188	194	185
42	Reserved for the system	note	0	0	0
43	JOG operation acceleration/deceleration time constant	ms	500	500	500
44	JOG operation feed pulse count	Pulse	100	100	100
45	JOG operation S-shape selection	—	0	0	0
46	JOG operation speed	r/min	500	500	500
47	Communication setting	—	0	0	0
48	CAN ID	note	0	0	0
49	CAN communication speed	note	0	0	0

Note: This area is reserved for the system. Do not perform any setting.

No.	Description	unit	FHA-11C-30	FHA-11C-50	FHA-11C-100
00	Position loop gain	—	40	40	40
01	Speed loop proportional gain	—	225	225	225
02	Speed loop integral gain	—	20	20	20
03	Speed loop derivative gain	—	0	0	0
04	Speed feed-forward factor	—	0	0	0
05	Acceleration feed-forward factor	—	0	0	0
06	Torque command filter	—	0	0	0
07	Speed step correction	—	0	0	0
08	Torque step correction	—	0	0	0
09	Step correction switch range	pulse	4000	4000	4000
10	Control mode	—	1	1	1
11	Input function assignment	—	0	0	0
12	Output function assignment	—	0	0	0
13	Input pin logical setting	—	0	0	0
14	Output pin logical setting	—	2	2	2
15	Control input filter time constant	ms	0	0	0
16	Speed limit	r/min	6000	6000	6000
17	FWD current limiting	%	211	234	200
18	REV current limiting	%	211	234	200
19	Regenerative brake ON/OFF	—	0	0	0
20	Rotary direction	—	0	0	0
21	Allowable position deviation	pulse	30000	30000	30000
22	In-position ready range	pulse	10	10	10
23	Command pulse input factor-numerator	—	1	1	1
24	Command pulse input factor-denominator	—	1	1	1
25	Command pulse input form	—	0	0	0
26	Multiplication at 2-phase input	—	4	4	4
27	Servo-ON deviation clear	—	0	0	0
28	Angle correction	—	0	0	0
29	Auto gain setting at positioning	—	1	1	1
30	Speed command input factor	r/min	6000	6000	6000
31	Attained speed determination value	r/min	2000	2000	2000
32	Internal speed command value	r/min	1	1	1
33	Acceleration time constant	ms	1	1	1
34	Deceleration time constant	ms	1	1	1
35	Analog command A/D value (Mid)	—	3447	3447	3447
36	Analog command A/D value (Max)	—	5984	5984	5984
37	Analog command A/D value (Min)	—	910	910	910
38	Zero clamp	—	0	0	0
39	Reserved for the system	note	0	0	0
40	Internal command input factor	%	1	1	1
41	Torque command input factor	—	211	234	200
42	Reserved for the system	note	0	0	0
43	JOG operation acceleration/deceleration time constant	ms	500	500	500
44	JOG operation feed pulse count	pulse	100	100	100
45	JOG operation S-shape selection	—	0	0	0
46	JOG operation speed	r/min	500	500	500
47	Communication setting	—	0	0	0
48	CAN ID	note	0	0	0
49	CAN communication speed	note	0	0	0

Note: This area is reserved for the system. Do not perform any setting.

No.	Description	unit	FHA-14C-30	FHA-14C-50	FHA-14C-100
00	Position loop gain	—	40	40	40
01	Speed loop proportional gain	—	250	250	250
02	Speed loop integral gain	—	20	20	20
03	Speed loop derivative gain	—	0	0	0
04	Speed feed-forward factor	—	0	0	0
05	Acceleration feed-forward factor	—	0	0	0
06	Torque command filter	—	0	0	0
07	Speed step correction	—	0	0	0
08	Torque step correction	—	0	0	0
09	Step correction switch range	pulse	4000	4000	4000
10	Control mode	—	1	1	1
11	Input function assignment	—	0	0	0
12	Output function assignment	—	0	0	0
13	Input pin logical setting	—	0	0	0
14	Output pin logical setting	—	2	2	2
15	Control input filter time constant	ms	0	0	0
16	Speed limit	r/min	6000	6000	6000
17	FWD current limiting	%	247	304	280
18	REV current limiting	%	247	304	280
19	Regenerative brake ON/OFF	—	0	0	0
20	Rotary direction	—	0	0	0
21	Allowable position deviation	pulse	30000	30000	30000
22	In-position ready range	pulse	10	10	10
23	Command pulse input factor-numerator	—	1	1	1
24	Command pulse input factor-denominator	—	1	1	1
25	Command pulse input form	—	0	0	0
26	Multiplication at 2-phase input	—	4	4	4
27	Servo-ON deviation clear	—	0	0	0
28	Angle correction	—	0	0	0
29	Auto gain setting at positioning	—	1	1	1
30	Speed command input factor	r/min	6000	6000	6000
31	Attained speed determination value	r/min	2000	2000	2000
32	Internal speed command value	r/min	1	1	1
33	Acceleration time constant	ms	1	1	1
34	Deceleration time constant	ms	1	1	1
35	Analog command A/D value (Mid)	—	3447	3447	3447
36	Analog command A/D value (Max)	—	5984	5984	5984
37	Analog command A/D value (Min)	—	910	910	910
38	Zero clamp	—	0	0	0
39	Reserved for the system	note	0	0	0
40	Internal command input factor	%	1	1	1
41	Torque command input factor	—	247	304	280
42	Reserved for the system	note	0	0	0
43	JOG operation acceleration/deceleration time constant	ms	500	500	500
44	JOG operation feed pulse count	pulse	100	100	100
45	JOG operation S-shape selection	—	0	0	0
46	JOG operation speed	r/min	500	500	500
47	Communication setting	—	0	0	0
48	CAN ID	note	0	0	0
49	CAN communication speed	note	0	0	0

Note: This area is reserved for the system. Do not perform any setting.

No.	Description	unit	RSF-3C-30	RSF-3C-50	RSF-3C-100
00	Position loop gain	–	100	100	100
01	Speed loop proportional gain	–	120	120	120
02	Speed loop integral gain	–	10	10	10
03	Speed loop derivative gain	–	0	0	0
04	Speed feed-forward factor	–	0	0	0
05	Acceleration feed-forward factor	–	0	0	0
06	Torque command filter	–	0	0	0
07	Speed step correction	–	0	0	0
08	Torque step correction	–	0	0	0
09	Step correction switch range	pulse	4000	4000	4000
10	Control mode	–	1	1	1
11	Input function assignment	–	0	0	0
12	Output function assignment	–	0	0	0
13	Input pin logical setting	–	0	0	0
14	Output pin logical setting	–	2	2	2
15	Control input filter time constant	ms	0	0	0
16	Speed limit	r/min	10000	10000	10000
17	FWD current limiting	%	327	278	230
18	REV current limiting	%	327	278	230
19	Regenerative brake ON/OFF	–	0	0	0
20	Rotary direction	–	0	0	0
21	Allowable position deviation	pulse	30000	30000	30000
22	In-position ready range	pulse	10	10	10
23	Command pulse input factor-numerator	–	1	1	1
24	Command pulse input factor-denominator	–	1	1	1
25	Command pulse input form	–	0	0	0
26	Multiplication at 2-phase input	–	4	4	4
27	Servo-ON deviation clear	–	0	0	0
28	Angle correction	–	0	0	0
29	Auto gain setting at positioning	–	0	0	0
30	Speed command input factor	r/min	10000	10000	10000
31	Attained speed determination value	r/min	2000	2000	2000
32	Internal speed command value	r/min	1	1	1
33	Acceleration time constant	ms	1	1	1
34	Deceleration time constant	ms	1	1	1
35	Analog command A/D value (Mid)	–	3447	3447	3447
36	Analog command A/D value (Max)	–	5984	5984	5984
37	Analog command A/D value (Min)	–	910	910	910
38	Zero clamp	–	0	0	0
39	Reserved for the system	note	0	0	0
40	Internal command input factor	%	1	1	1
41	Torque command input factor	–	327	278	230
42	Reserved for the system	note	0	0	0
43	JOG operation acceleration/deceleration time constant	ms	500	500	500
44	JOG operation feed pulse count	pulse	100	100	100
45	JOG operation S-shape selection	–	0	0	0
46	JOG operation speed	r/min	500	500	500
47	Communication setting	–	0	0	0
48	CAN ID	note	0	0	0
49	CAN communication speed	note	0	0	0

Note: This area is reserved for the system. Do not perform any setting.

No.	Description	unit	RSF-5B-30	RSF-5B-50	RSF-5B-100
00	Position loop gain *	—	100 (120)	100 (120)	100 (120)
01	Speed loop proportional gain *	—	65 (130)	65 (130)	65 (130)
02	Speed loop integral gain	—	10	10	10
03	Speed loop derivative gain	—	20	20	20
04	Speed feed-forward factor	—	0	0	0
05	Acceleration feed-forward factor	—	0	0	0
06	Torque command filter	—	0	0	0
07	Speed step correction	—	0	0	0
08	Torque step correction	—	0	0	0
09	Step correction switch range	pulse	4000	4000	4000
10	Control mode	—	1	1	1
11	Input function assignment	—	0	0	0
12	Output function assignment	—	0	0	0
13	Input pin logical setting	—	0	0	0
14	Output pin logical setting	—	2	2	2
15	Control input filter time constant	ms	0	0	0
16	Speed limit	r/min	10000	10000	10000
17	FWD current limiting	%	211	257	253
18	REV current limiting	%	211	257	253
19	Regenerative brake ON/OFF	—	0	0	0
20	Rotary direction	—	0	0	0
21	Allowable position deviation	pulse	30000	30000	30000
22	In-position ready range	pulse	10	10	10
23	Command pulse input factor-numerator	—	1	1	1
24	Command pulse input factor-denominator	—	1	1	1
25	Command pulse input form	—	0	0	0
26	Multiplication at 2-phase input	—	4	4	4
27	Servo-ON deviation clear	—	0	0	0
28	Angle correction	—	0	0	0
29	Auto gain setting at positioning	—	1	1	1
30	Speed command input factor	r/min	10000	10000	10000
31	Attained speed determination value	r/min	2000	2000	2000
32	Internal speed command value	r/min	1	1	1
33	Acceleration time constant	ms	1	1	1
34	Deceleration time constant	ms	1	1	1
35	Analog command A/D value (Mid)	—	3447	3447	3447
36	Analog command A/D value (Max)	—	5984	5984	5984
37	Analog command A/D value (Min)	—	910	910	910
38	Zero clamp	—	0	0	0
39	Reserved for the system	note	0	0	0
40	Internal command input factor	%	1	1	1
41	Torque command input factor	—	211	266	253
42	Reserved for the system	note	0	0	0
43	JOG operation acceleration/deceleration time constant	ms	500	500	500
44	JOG operation feed pulse count	pulse	100	100	100
45	JOG operation S-shape selection	—	0	0	0
46	JOG operation speed	r/min	500	500	500
47	Communication setting	—	0	0	0
48	CAN ID	note	0	0	0
49	CAN communication speed	note	0	0	0

Note: This area is reserved for the system. Do not perform any setting.
*: The value shown inside of parentheses is for the actuator with brakes.

No.	Description	unit	RSF-8B-30	RSF-8B-50	RSF-8B-100
00	Position loop gain *	—	40	40	40
01	Speed loop proportional gain *	—	120	120	120
02	Speed loop integral gain	—	20	20	20
03	Speed loop derivative gain	—	0	0	0
04	Speed feed-forward factor	—	0	0	0
05	Acceleration feed-forward factor	—	0	0	0
06	Torque command filter	—	0	0	0
07	Speed step correction	—	0	0	0
08	Torque step correction	—	0	0	0
09	Step correction switch range	pulse	4000	4000	4000
10	Control mode	—	1	1	1
11	Input function assignment	—	0	0	0
12	Output function assignment	—	0	0	0
13	Input pin logical setting	—	0	0	0
14	Output pin logical setting	—	2	2	2
15	Control input filter time constant	ms	0	0	0
16	Speed limit	r/min	6000	6000	6000
17	FWD current limiting	%	190	195	193
18	REV current limiting	%	190	195	193
19	Regenerative brake ON/OFF	—	0	0	0
20	Rotary direction	—	0	0	0
21	Allowable position deviation	pulse	30000	30000	30000
22	In-position ready range	pulse	10	10	10
23	Command pulse input factor-numerator	—	1	1	1
24	Command pulse input factor-denominator	—	1	1	1
25	Command pulse input form	—	0	0	0
26	Multiplication at 2-phase input	—	4	4	4
27	Servo-ON deviation clear	—	0	0	0
28	Angle correction	—	0	0	0
29	Auto gain setting at positioning	—	0	1	1
30	Speed command input factor	r/min	6000	6000	6000
31	Attained speed determination value	r/min	2000	2000	2000
32	Internal speed command value	r/min	1	1	1
33	Acceleration time constant	ms	1	1	1
34	Deceleration time constant	ms	1	1	1
35	Analog command A/D value (Mid)	—	3447	3447	3447
36	Analog command A/D value (Max)	—	5984	5984	5984
37	Analog command A/D value (Min)	—	910	910	910
38	Zero clamp	—	0	0	0
39	Reserved for the system	note	0	0	0
40	Internal command input factor	%	1	1	1
41	Torque command input factor	—	190	195	193
42	Reserved for the system	note	0	0	0
43	JOG operation acceleration/deceleration time constant	ms	500	500	500
44	JOG operation feed pulse count	pulse	100	100	100
45	JOG operation S-shape selection	—	0	0	0
46	JOG operation speed	r/min	500	500	500
47	Communication setting	—	0	0	0
48	CAN ID	note	0	0	0
49	CAN communication speed	note	0	0	0

Note: This area is reserved for the system. Do not perform any setting.

*: The value shown inside of parentheses is for the actuator with brakes.

No.	Description	unit	RSF-11B-30	RSF-11B-50	RSF-11B-100
00	Position loop gain *	—	40	40	40
01	Speed loop proportional gain *	—	140	140	140
02	Speed loop integral gain	—	20	20	20
03	Speed loop derivative gain	—	0	0	0
04	Speed feed-forward factor	—	0	0	0
05	Acceleration feed-forward factor	—	0	0	0
06	Torque command filter	—	0	0	0
07	Speed step correction	—	0	0	0
08	Torque step correction	—	0	0	0
09	Step correction switch range	pulse	4000	4000	4000
10	Control mode	—	1	1	1
11	Input function assignment	—	0	0	0
12	Output function assignment	—	0	0	0
13	Input pin logical setting	—	0	0	0
14	Output pin logical setting	—	2	2	2
15	Control input filter time constant	ms	0	0	0
16	Speed limit	r/min	6000	6000	6000
17	FWD current limiting	%	288	322	191
18	REV current limiting	%	288	322	191
19	Regenerative brake ON/OFF	—	0	0	0
20	Rotary direction	—	0	0	0
21	Allowable position deviation	pulse	30000	30000	30000
22	In-position ready range	pulse	10	10	10
23	Command pulse input factor-numerator	—	1	1	1
24	Command pulse input factor-denominator	—	1	1	1
25	Command pulse input form	—	0	0	0
26	Multiplication at 2-phase input	—	4	4	4
27	Servo-ON deviation clear	—	0	0	0
28	Angle correction	—	0	0	0
29	Auto gain setting at positioning	—	1	1	1
30	Speed command input factor	r/min	6000	6000	6000
31	Attained speed determination value	r/min	2000	2000	2000
32	Internal speed command value	r/min	1	1	1
33	Acceleration time constant	ms	1	1	1
34	Deceleration time constant	ms	1	1	1
35	Analog command A/D value (Mid)	—	3447	3447	3447
36	Analog command A/D value (Max)	—	5984	5984	5984
37	Analog command A/D value (Min)	—	910	910	910
38	Zero clamp	—	0	0	0
39	Reserved for the system	note	0	0	0
40	Internal command input factor	%	1	1	1
41	Torque command input factor	—	288	322	191
42	Reserved for the system	note	0	0	0
43	JOG operation acceleration/deceleration time constant	ms	500	500	500
44	JOG operation feed pulse count	pulse	100	100	100
45	JOG operation S-shape selection	—	0	0	0
46	JOG operation speed	r/min	500	500	500
47	Communication setting	—	0	0	0
48	CAN ID	note	0	0	0
49	CAN communication speed	note	0	0	0

Note: This area is reserved for the system. Do not perform any setting.
*: The value shown inside of parentheses is for the actuator with brakes.

No.	Description	unit	RSF-14B-30	RSF-14B-50	RSF-14B-100
00	Position loop gain *	—	40	40	40
01	Speed loop proportional gain *	—	120	120	120
02	Speed loop integral gain	—	20	20	20
03	Speed loop derivative gain	—	0	0	0
04	Speed feed-forward factor	—	0	0	0
05	Acceleration feed-forward factor	—	0	0	0
06	Torque command filter	—	0	0	0
07	Speed step correction	—	0	0	0
08	Torque step correction	—	0	0	0
09	Step correction switch range	pulse	4000	4000	4000
10	Control mode	—	1	1	1
11	Input function assignment	—	0	0	0
12	Output function assignment	—	0	0	0
13	Input pin logical setting	—	0	0	0
14	Output pin logical setting	—	2	2	2
15	Control input filter time constant	ms	0	0	0
16	Speed limit	r/min	6000	6000	6000
17	FWD current limiting	%	293	365	261
18	REV current limiting	%	293	365	261
19	Regenerative brake ON/OFF	—	0	0	0
20	Rotary direction	—	0	0	0
21	Allowable position deviation	pulse	30000	30000	30000
22	In-position ready range	pulse	10	10	10
23	Command pulse input factor-numerator	—	1	1	1
24	Command pulse input factor-denominator	—	1	1	1
25	Command pulse input form	—	0	0	0
26	Multiplication at 2-phase input	—	4	4	4
27	Servo-ON deviation clear	—	0	0	0
28	Angle correction	—	0	0	0
29	Auto gain setting at positioning	—	1	1	1
30	Speed command input factor	r/min	6000	6000	6000
31	Attained speed determination value	r/min	2000	2000	2000
32	Internal speed command value	r/min	1	1	1
33	Acceleration time constant	ms	1	1	1
34	Deceleration time constant	ms	1	1	1
35	Analog command A/D value (Mid)	—	3447	3447	3447
36	Analog command A/D value (Max)	—	5984	5984	5984
37	Analog command A/D value (Min)	—	910	910	910
38	Zero clamp	—	0	0	0
39	Reserved for the system	note	0	0	0
40	Internal command input factor	%	1	1	1
41	Torque command input factor	—	293	365	261
42	Reserved for the system	note	0	0	0
43	JOG operation acceleration/deceleration time constant	ms	500	500	500
44	JOG operation feed pulse count	pulse	100	100	100
45	JOG operation S-shape selection	—	0	0	0
46	JOG operation speed	r/min	500	500	500
47	Communication setting	—	0	0	0
48	CAN ID	note	0	0	0
49	CAN communication speed	note	0	0	0

Note: This area is reserved for the system. Do not perform any setting.

*: The value shown inside of parentheses is for the actuator with brakes.

7. Troubleshooting

7.1 Alarms and diagnostic tips

The HA-680 drive provide various functions to protect the actuators and drivers against abnormal operating conditions. When these protection functions trip, the actuator is stopped (the motor becomes servo-off), and the display LED blinks at 0.5-second intervals. (It illuminates in green and blinks in red: The number of times it blinks varies depending on the alarm. See below.)

If two or more alarms occur, only the latest alarm is displayed. Up to 8 latest alarms are recorded. Recorded alarms can be checked with "Alarm History" using the dedicated communication software PSF-520.

Alarm code	Description	No. of times LED blinks	Releasing
Overload	Electronic thermal detection of an overload state (I ² t monitoring).	1	Available *1
Deviation counter overflow	The value of the deviation counter exceeded the parameter value.	2	Available *1
Encoder break detection	The encoder line was broken.	3	Not available *2
Encoder reception error	Serial encoder data could not be received 10 times in a row.	4	Not available *2
	Serial encoder data could not be received over an extended time period, and encoder monitor could not be outputted successfully.	5	
UVW error	All encoder U/V/W signals are the same level.	6	Not available *2
Regenerative error	The main circuit voltage detection circuit detected overvoltage.	7	Not available *2
Operating temperature error	The temperature of the HA-680 main unit tripped the temperature rise sensor.	8	Not available *2
System error	An error in the current detection circuit was sensed.	9	Not available *2
Overcurrent	The current detection circuit sensor excessive current.	10	Not available *2
Load short circuit	Excessive current flowed through the FET.	11	Not available *2
Memory error	EEPROM Read/write failed.	12	Not available *2
Overspeed	The motor axis speed exceeded the maximum rotation speed +100 rpm for 0.5 s or longer.	13	Not available *2

*1 The servo does not turn on unless the S-ON signal is entered again after the alarm is cleared with the CLR signal.

*2 Turn off the power after handling the alarm. After that, turn on the power again by following the power on sequence.

The following example illustrates how the LED blinks in case of an alarm.

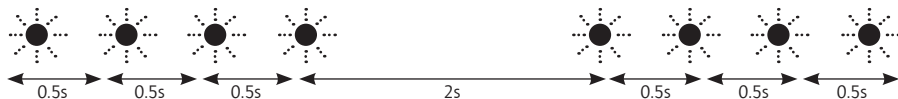

In the above example, the LED blinks 4 times at 0.5-s intervals, which indicates an "encoder reception error."



Do not make wiring works after powering the driver for troubleshooting.

The troubleshooting while power is active may result in getting electric shocks. Shut off the electric power source before any wiring changes are made.



1. Clean around the device. Make sure there are no wire chips or tools inside the equipment.
2. When two or more persons are working on the equipment, make sure all are alerted and safe before power is restored to the machine.

Overload (Alarm clear: available)

● Description

The driver always monitors the motor current, and if the current exceeds the curve in the figure below, the overload alarm occurs. Occurrence of the overload alarm varies depending on the actuator.

Overload alarm occurrence time

FHA-C mini AC24V type

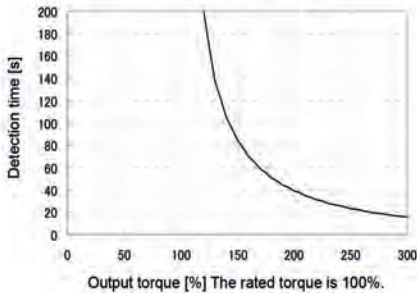

FHA-C mini AC24V type

- | | |
|-----|---|
| (1) | The alarm occurs when a current of more than 1.25 times the allowable continuous current of the actuator flows for about 170 seconds. |
| (2) | The alarm occurs when a current of 3 times the allowable continuous current of the actuator flows for about 16 seconds. |

RSF supermini series

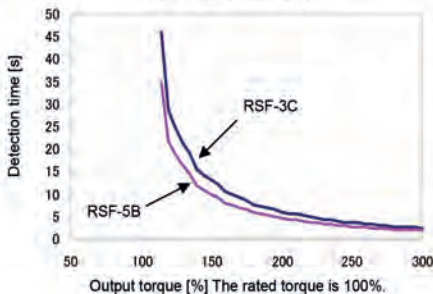

RSF supermini series(RSF-5B)

- | | |
|-----|---|
| (1) | The alarm occurs when a current of more than 1.2 times the allowable continuous current of the actuator flows for about 35(45) seconds. |
| (2) | The alarm occurs when a current of 2 times the allowable continuous current of the actuator flows for about 5(6) seconds. |

()The inside is RSF-3C

RSF-B mini series

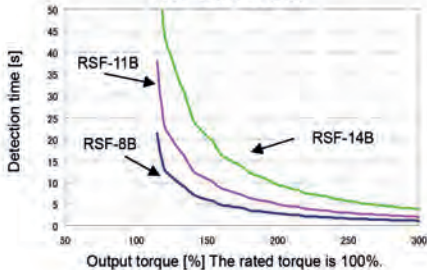

RSF-8B

- | | |
|-----|---|
| (1) | The alarm occurs when a current of more than 1.2 times the allowable continuous current of the actuator flows for about 13 seconds. |
| (2) | The alarm occurs when a current of 1.5 times the allowable continuous current of the actuator flows for about 6 seconds. |

RSF-11B	
(1)	The alarm occurs when a current of more than 1.2 times the allowable continuous current of the actuator flows for about 23 seconds.
(2)	The alarm occurs when a current of 1.5 times the allowable continuous current of the actuator flows for about 10 seconds.

RSF-14B	
(1)	The alarm occurs when a current of more than 1.2 times the allowable continuous current of the actuator flows for about 45 seconds.
(2)	The alarm occurs when a current of 2.5 times the allowable continuous current of the actuator flows for about 5 seconds.

It is possible to clear the alarm by inputting ON signal to [CN2 Clear or Alarm clear] if it is not overload, again.

Diagnostic tips

(1) Alarm occurs when control power is turned on:

- Cause 1: The control circuit of the HA-680 drive may have failed.
- ▶ Remedy: Contact Harmonic Drive AG.(Replace the HA-680 drive)

(2) The alarm occurs while running (it is possible to restart after shutting off control power):

- Cause 1: Actuator overloaded
- ▶ Remedy: Review the actuator's actual load profile to lower the cycle.

(3) Alarm occurs after hunting motion:

- Cause 1: Hunting motion is caused by poor gain adjustment
- ▶ Remedy: Adjust gains in [parameter]→[00: position loop gain], [01: Speed loop proportional gain],

[02: speed loop integral gain] and [03: Speed loop derivative gain] proportional to the load.

(4) Alarm does not occur when driving the actuator only (no load), but alarm occurs with load:

- Cause 1: Wrong connection of motor and encoder cables
- ▶ Remedy: Connect cables correctly referring to [chapter 3 : Installing the HA-680 drive] in this manual.

(5) Alarm occurs when driving the actuator only (no load):

- Cause 1: Wrong connection of motor and encoder cables
- ▶ Remedy: Connect cables correctly referring to [chapter 3: Installing the HA-680 drive] in this manual.

Deviation counter overflow (Alarm clear: available)

Description

The alarm occurs when the value of the deviation counter exceeds the parameter setting value (PSF-520 No.21 Allowable position deviation). This alarm

can be reset by inputting an ON signal to "CN2 Alarm Clear: ALM-CLR" after inputting an ON signal to "CN2 Clear: CLEAR" or "CN2 Deviation Clear: DEV-CLR."

Diagnostic tips

(1) If the alarm occurs when the power is turned on:

- Cause 1: Main circuit was turned ON while inputting command pulse. The power was applied while the actuator was driving.
- ▶ Remedy: Stop command pulse or the actuator, and turn on the power, again.

- Cause 2: HA-680 drive control circuit failure
- ▶ Remedy: Contact Harmonic Drive AG. (Replace the HA-680 drive)

(2) If the alarm occurs during acceleration or deceleration:

- Cause 1: Gain is too low.
- ▶ Remedy: Adjust gains in [parameter]→[00: position loop gain], [01: Speed loop proportional gain], [02: speed loop integral gain] and [03: Speed loop derivative gain] proportional to the load.
- Cause 2: Parameters of the [Command pulse input factor] are wrong.
- ▶ Remedy: Set the parameter correctly in [parameter]→[23: Command pulse input factor-numerator], [24: Command pulse input factor-denominator].
- Cause 3: [Command pulse frequency] is too large.
- ▶ Remedy: Decrease the [Command output pulse frequency] setting of the higher-level system. The appropriate frequency is normal rotation speed of actuator (r/min) x 60 or less.

- Cause 4: The load inertia is too large.

- ▶ Remedy 1: Reduce the load inertia.
- ▶ Remedy 2: Modify the command pulse frequency of the host to accelerate and decelerate more slowly.

(3) If the speed does not increase according to the command and the alarm occurs after a while:

- Cause 1: OFF state of input signal [CN2: FWD inhibit] or [CN2: REV inhibit].
- ▶ Remedy: Verify breakage of CN2 connector cable.

(4) Actuator did not rotate.

- Cause 1: Incorrect motor cable connection or wrong phase order
- ▶ Remedy 1: Correct the connection between the motor cable and the connector.
- ▶ Remedy 2: Connect the motor cable and the connector in correct phase order referring to [Chapter 3-7: Connecting motor and regeneration resistor cables] of this manual.
- Cause 2: Poor encoder connector (CN1) connection.
- ▶ Remedy: Plug the CN1 connector firmly.

Encoder break detection (Alarm clear: not available)

Description

This alarm occurs when the encoder signal ceases (usually, an encoder break is detected). To release

the alarm after troubleshooting, shut off the control power and turn it on again.

Diagnostic tips

(1) Alarm occurs when the control power is turned on:

- Cause 1: The encoder connector (CN1) may not be connected or may be improperly wired, or encoder may be broken.
- ▶ Remedy: Verify connection of encoder connector (CN1) and connect it firmly.
- Cause 2: The encoder circuit may have failed.
- ▶ Remedy: Contact Harmonic Drive AG.(Replace actuator)
- Cause 3: The control circuit of the HA-680 drive may have failed.

- ▶ Remedy: Contact Harmonic Drive AG. (Replace the HA-680 drive)

(2) Alarm occurs during running (recovers when the actuator cooled down)

- Cause 1: Encoder malfunctions when the actuator temperature rises.
- ▶ Remedy: Review the actuator operating load, duty cycle, and its cooling system.

Encoder reception error (Alarm clear: not available)

Description

This alarm occurs when the driver fails to receive data from encoder. The alarm also occurs when the driver fails to output the encoder signal. To release

the alarm after troubleshooting, shut off the control power and turn it on again.

Diagnostic tips

(1) Alarm occurs when the control power is turned on:

- Cause 1: The encoder connector (CN1) may not be connected or may be connected poorly.
- ▶ Remedy: Verify connection of encoder connector (CN1) and connect it firmly.
- Cause 2: The encoder circuit may have failed.
- ▶ Remedy: Contact Harmonic Drive AG. (Replace actuator)

- Cause 3: The control circuit of the HA-680 drive may have failed.
- ▶ Remedy: Contact Harmonic Drive AG. (Replace the HA-680 drive)

(2) Alarm occurs temporarily while running:

- Cause 1: Malfunction may be caused by surrounding electrical noise.
- ▶ Remedy: Install the driver correctly referring [Chapter 3.4: Suppressing noise] in this manual.

UVW error (Alarm clear: not available)

Description

The alarm occurs when the encoder UVW signals are abnormal. To release the alarm after troubleshooting, shut off the control power and turn it on again.

Diagnostic tips

(1) Alarm occurs when the control power is turned on:

- Cause 1: The encoder connector (CN1) may not be connected or may be connected poorly.
- ▶ Remedy: Verify connection of encoder connector (CN1) and connect it firmly.
- Cause 2: The encoder circuit may have failed.
- ▶ Remedy: Contact Harmonic Drive AG. (Replace actuator)

- Cause 3: The control circuit of the HA-680 drive may have failed.
- ▶ Remedy: Contact Harmonic Drive AG. (Replace the HA-680 drive)

(2) Alarm occurs temporarily while running:

- Cause 1: Malfunction may be caused by surrounding electrical noise.
- ▶ Remedy: Install the driver correctly referring [Chapter 3-4: Suppressing noise] in this manual.

Regenerative error (Alarm clear: not available)

Description

The alarm occurs when the voltage of the main circuit exceeds 50 V. If the load inertia is large, the main circuit voltage increases due to the energy generated during deceleration of the actuator. This alarm can be cleared by shutting down the control circuit power and turning it on again. However, this alarm may occur every time under the same load conditions. Connect a regenerative resistance to the external regenerative resistance connection terminal, or extend the acceleration/ deceleration time. If a regenerative resistance is connected, you must switch the regenerative resistance switching jumper to the external connection.

The regenerative resistance of the regenerative absorption circuit incorporates a fuse. When the temperature of the regenerative resistance increases due to excessive regeneration and the fuse is blown, the regenerative circuit no longer works, and the main circuit voltage increases. If the regenerative error occurs immediately the control circuit power is shut down and turned on again, it may be due to a blown fuse. In this case, connect an external regenerative resistance and switch the jumper setting.

Diagnostic tips

(1) Alarm occurs while the motor is running:

- Cause 1: The load inertia is too large.
 - ▶ Remedy 1: Connect an external resistance or capacitor according to "3.8 Connecting regenerative absorption resistances/capacitors" in this manual.

- ▶ Remedy 2: Extend the deceleration time.
- ▶ Remedy 3: Lower the maximum speed.
- ▶ Remedy 4: Reduce the load inertia.
- Cause 2: Failure of the overload detection circuit.
 - ▶ Remedy: Contact Harmonic Drive AG. (Replace the HA-680 drive)

Operating temperature error (Alarm clear: not available)

Description

The alarm occurs when the temperature of the HA-680 main unit increases and the temperature sensor trips. To release the alarm after troubleshooting, shut off the control power and turn it on again.

Diagnostic tips

(1) Alarm occurs when the control circuit power is turned on:

- Cause 1: Failure of the temperature sensor of the HA-680 drive.
 - ▶ Remedy: Contact Harmonic Drive AG. (Replace the HA-680 drive)

(2) Alarm occurs while the motor is running:

- Cause 1: The motor is in an overload state while running.

- ▶ Remedy: Review the effective load factor of the actuator to reduce the load factor.
- Cause 2: The ambient temperature around the HA-680 drive is over 50°C.
 - ▶ Remedy: Review the installation location and cooling system of the HA-680 drive.

System error (Alarm clear: not available)

Description

This alarm occurs when an error of the current detection circuit is detected. To release the alarm after troubleshooting, shut off the control power and turn it on again.

Diagnostic tips

(1) Alarm occurs when the control circuit power is turned on:

- Cause 1: Failure of the current detection circuit of the HA-680 drive
 - ▶ Remedy: Contact Harmonic Drive AG. (Replace the HA-680 drive)

(2) Alarm occurs occasionally while the motor is running:

- Cause 1: Malfunction due to external noise
 - ▶ Remedy: Take noise prevention measures according to "3.4 Suppressing noise" in this manual.
- Cause 2: Failure of the current detection circuit of the HA-680 drive
 - ▶ Remedy: Contact Harmonic Drive AG. (Replace the HA-680 drive)

Overcurrent (Alarm clear: not available)

Description

This alarm occurs when the current detection circuit detects the over current. To release the alarm after troubleshooting, shut off the control power and turn it on again.

Diagnostic tips

(1) Alarm occurs when control power is turned on:

- Cause 1: The control circuit of the HA-680 drive may have failed.
- ▶ Remedy: Contact Harmonic Drive AG. (Replace the HA-680 drive)

(2) Alarm occurs when input signal of [CN2-7: S-ON (servo-ON)] is activated:

- Cause 1: The control or main circuit of the HA-680 drive may have failed.
- ▶ Remedy: Contact Harmonic Drive AG. (Replace the HA-680 drive)

(3) Alarm occurs when input signal of [CN2-7: S-ON (servo-ON)] is activated, but doesn't occur when the input signal is ON and the motor cable (U, V, W) is disconnected:

- Cause 1: Short connection in the motor cable
- ▶ Remedy: Verify the connection of the motor cable and correct it or replace it if necessary.
- Cause 2: Short connection in the motor winding
- ▶ Remedy: Contact Harmonic Drive AG. (Replace actuator)

(4) Alarm occurs during acceleration or deceleration:

- Cause 1: Excessive load inertia and the accelerating or decelerating time is too short.
- ▶ Remedy 1: Reduce the load inertia.
- ▶ Remedy 2: Set longer times for [parameter]→[33: acceleration time constant] and [34: deceleration time constant].
- Cause 2: Gain is set too high or too low
- ▶ Remedy 1: Adjust gains in [parameter]→[00: position loop gain], [01: Speed loop proportional gain], [02: speed loop integral gain] and [03: Speed loop derivative gain] proportional to the load.

(5) The alarm occurs while running (it is possible to restart after 4 to 5 minutes):

- Cause 1: Actuator overloaded
- ▶ Remedy: Review the actuator's actual load profile to lower the duty.
- Cause 2: Ambient temperature of the HA-680 drive is more than 50° C.
- ▶ Remedy: Review the driver's installation and its cooling system.

Load short circuit (Alarm clear: not available)

Description

The alarm occurs when excessive current flows through the FET. To release the alarm after troubleshooting, shut off the control power and turn it on again.

Diagnostic tips

(1) Alarm occurs when the control circuit power is turned on:

- Cause 1: Failure of the control circuit of the HA-680 drive
- ▶ Remedy: Contact Harmonic Drive AG. (Replace the HA-680 drive)

(2) Alarm occurs with input (ON) of the input signal "CN2-7: Servo on":

- Cause 1: Failure of the main circuit or control circuit of the HA-680 drive
- ▶ Remedy: Contact Harmonic Drive AG. (Replace

the HA-680 drive)

(3) Alarm occurs by input signal of [CN2-7: S-ON (servo-ON)] is activated, but doesn't occur when the input signal is ON and the motor cable (U, V, W) is disconnected:

- Cause 1: Short connection in the motor cable
- ▶ Remedy: Verify the connection of the motor cable and correct it or replace it if necessary.
- Cause 2: Short connection in the motor winding
- ▶ Remedy: Contact Harmonic Drive AG. (Replace actuator)

(4) Alarm occurs during acceleration or deceleration:

- Cause 1: Excessive load inertia and the accelerating or decelerating time is too short.
- ▶ Remedy 1: Reduce the load inertia.
- ▶ Remedy 2: Set longer times for [parameter]→[33: acceleration time constant] and [34: deceleration time constant].
- Cause 2: Gain is set too high or too low
- ▶ Remedy 1: Adjust gains in [parameter]→[00: position loop gain], [01: Speed loop proportional gain], [02: speed loop integral gain] and [03: Speed loop derivative gain] proportional to the load.

Memory Error (EEPROM) (Alarm clear: not available)

Description

This alarm occurs when the driver's EEPROM memory fails. To release the alarm after troubleshooting, shut off the control power and turn it on again

Diagnostic tips

(1) Alarm occurs when the control power is turned on:

- Cause 1: The control circuit of the HA-680 drive may have failed.
- ▶ Remedy: Contact Harmonic Drive AG. (Replace the HA-680 drive)

Over speed (Alarm clear: not available)

Description

The alarm occurs when the motor axis speed exceeds the maximum rotation speed +100 rpm for 0.5 s or

Diagnostic tips

(1) Alarm occurs when the control circuit power is turned on:

- Cause 1: Failure of the control circuit of the HA-680 drive
- ▶ Remedy: Contact Harmonic Drive AG. (Replace the HA-680 drive)

(2) Alarm occurs when you enter a rotation command and the actuator rotates at high speed:

- Cause 1: (Position control) "Command pulse frequency" is too large.
- ▶ Remedy: Lower the "command pulse frequency" in the host device. Set it to a frequency lower than the maximum rotation speed (r/min) of the actuator.
- Cause 2: (Speed control) "Speed command input voltage" is too high.
- ▶ Remedy: Lower the "speed command output voltage" in the host device.

(5) The alarm occurs while running (it is possible to restart after 4 to 5 minutes):

- Cause 1: Running in an overloaded state
- ▶ Remedy: Review the actuator's actual load profile to lower the duty.
- Cause 2: Ambient temperature of the HA-680 drive is more than 50° C.
- ▶ Remedy: Review the driver's installation and it's cooling system.

(2) Alarm occurs during running

- Cause 1: Malfunction of a control circuit element of the HA-680 drive
- ▶ Remedy: Contact Harmonic Drive AG. (Replace the HA-680 drive)

longer. It can be reset by shutting down the power and turning it on again.

- Cause 3: "Speed command input factor" is too high.
- ▶ Remedy: Lower [30: Speed command input factor] in [Parameter].
- Cause 4: Wrong setting of "analog voltage command gain"
- ▶ Remedy: Change [30: Speed command input factor] in [Parameter].
- Cause 5: A significant overshoot due to insufficient gain adjustment
- ▶ Remedy: Adjust gains in [parameter]→ [01: Speed loop proportional gain], [02: speed loop integral gain] and [03: Speed loop derivative gain] proportional to the load.
- Cause 6: Wrong connection of the motor or encoder
- ▶ Remedy: Connect properly by referring to "Chapter 3 Installing HA-680 drive" in this manual.

7.2 Troubleshooting for improper actuator motions

Troubleshooting procedures for problems other than alarms are described separately in the position control, in the speed control and in the torque control modes. They are also described for the following cases:

- No rotation
- Unstable rotation
- Poor positioning accuracy

Note: In the flowcharts, "Y" and "N" represent "Yes" and "No", respectively.

7.2.1 Improper motions in position control

No rotation in position control

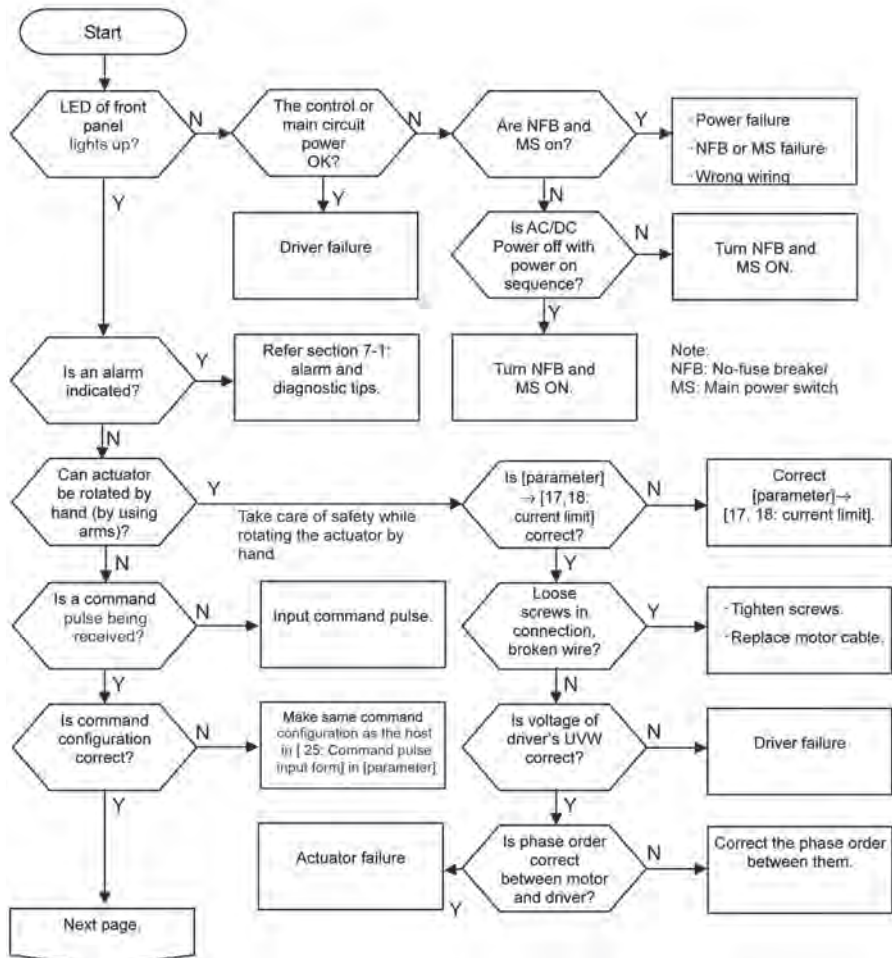

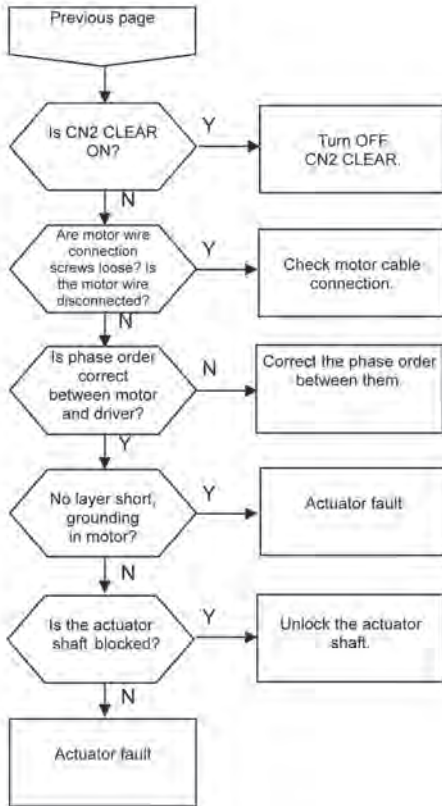

Unstable rotation in position control

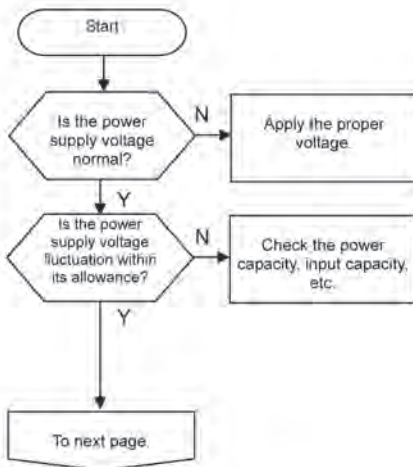

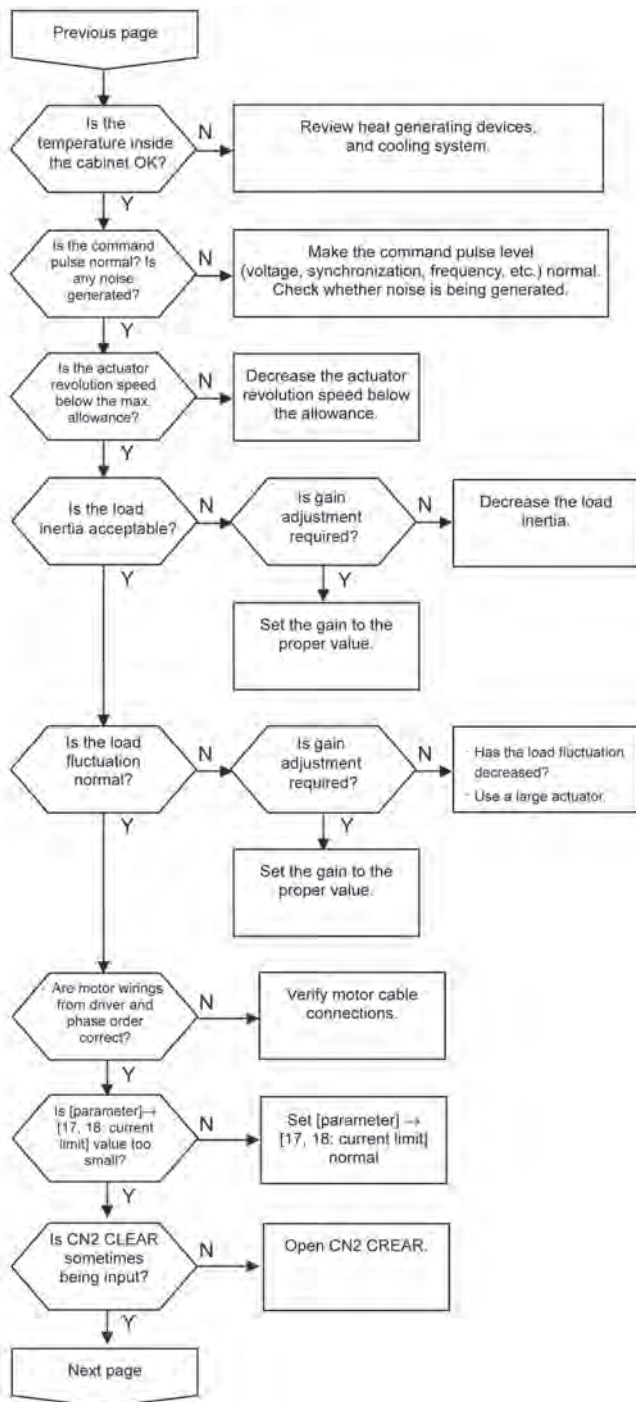

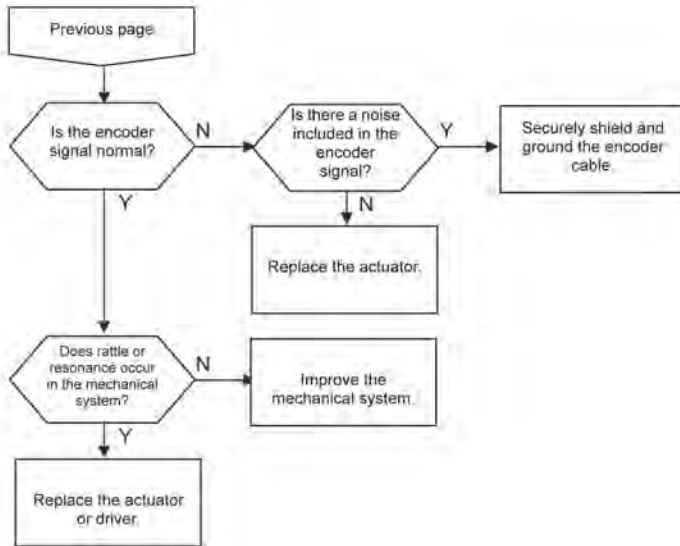

Poor positioning accuracy in position control

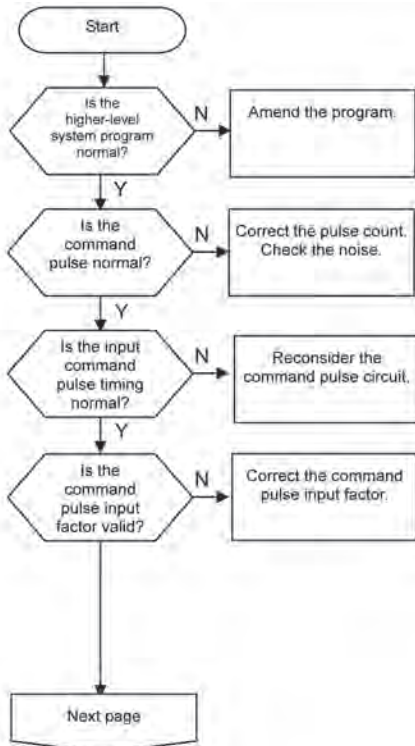

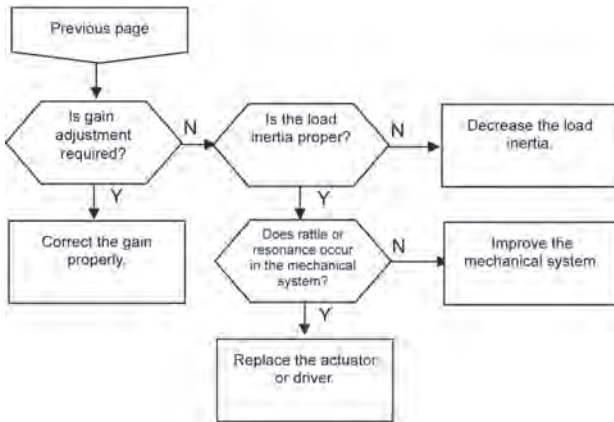

7.2.2 Improper motions in speed and torque control

No rotation in speed and torque control

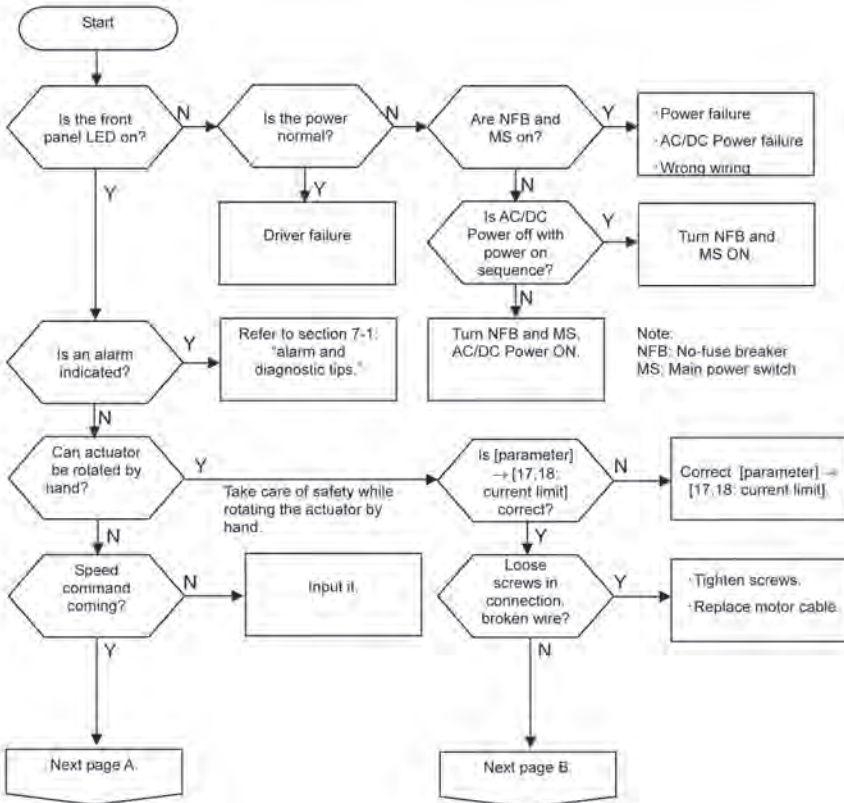

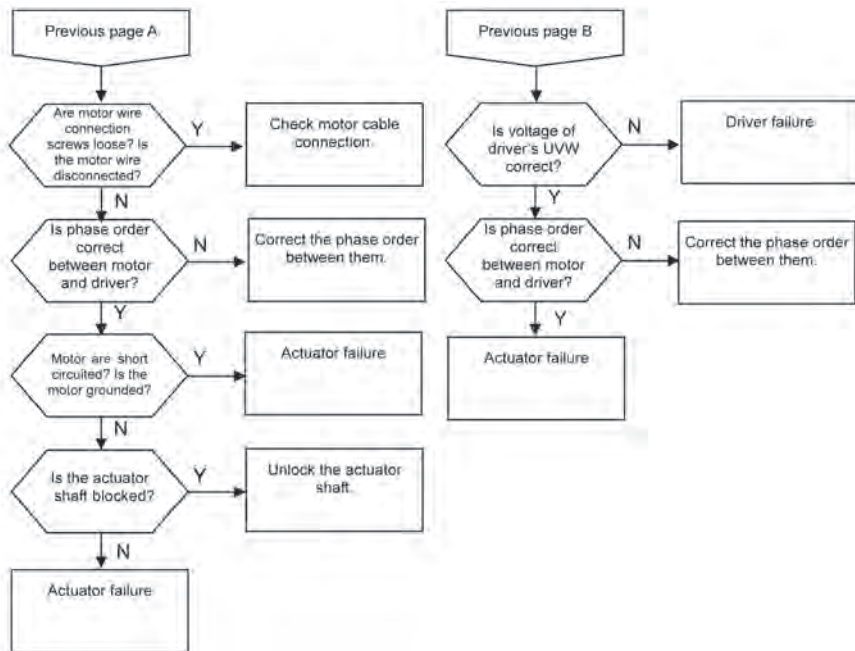

Unstable rotation in speed and torque control

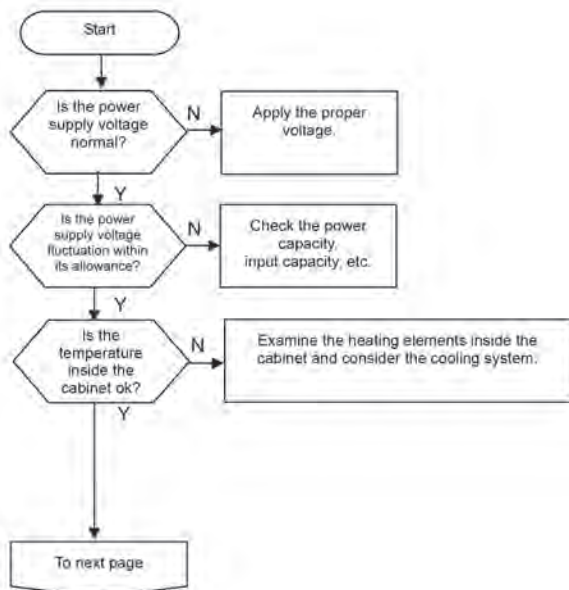

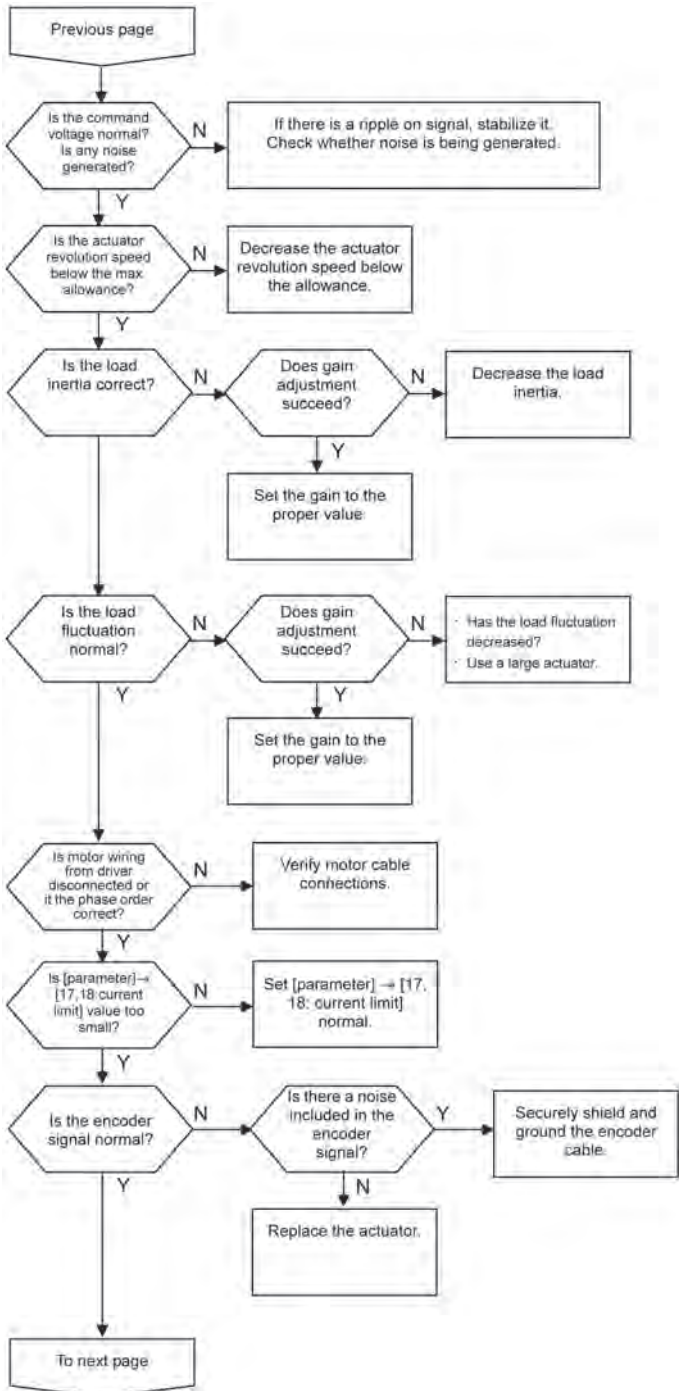

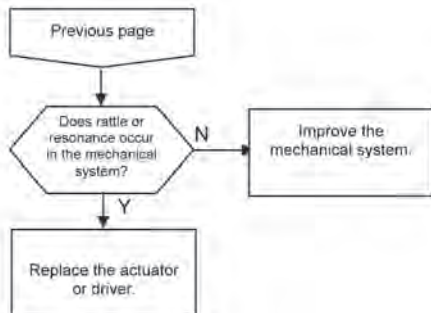

8. Options

8.1 Relay cables

Relay cable 1: FHA-C mini 24 VAC type

(4-wire encoder only)

These are relay cables that connect the FHA-C mini 24 VAC-type actuators and HA-680 driver. There are 3 types of relay cable: for motors, for encoders, and for EIA-232C.

Relay cable models

("**" indicates the cable length (3 m, 5 m, or 10 m))

(1) For motors:

EWC-MB**-A06-TN2

└────────── Cable length (03=3 m, 05=5 m, 10=10 m)

(2) For encoders:

EWC-E**-M06-3M14

└────────── Cable length (03=3 m, 05=5 m, 10=10 m)

(3) For EIA-232C:

HDM-RS232C Cable length: 1.5m

Relay cable 2: RSF supermini series

These are relay cables that connect the RSF supermini series actuators and HA-680 driver. There are 3 types of relay cable: for motors, for encoders, and for EIA-232C.

Relay cable models

("**" indicates the cable length (3 m, 5 m, or 10 m).)

(1) For motors:

EWA-M**-JST04-TN2 => for RSF-3C/5B

└────────── Cable length (03=3 m, 05=5 m, 10=10 m)

EWC-MBxx-A06-TN2 => for RSF-8B/-11B/-14B

(2) For encoders:

EWA-E**-JST09-3M14 => for RSF-3C/5B

└────────── Cable length (03=3 m, 05=5 m, 10=10 m)

EWB-Fxx-M0809-3M14 => for RSF-8B/-11B/-14B

(3) For EIA-232C:

HDM-RS232C Cable length: 1.5 m

When you use an actuator with a brake, a relay cable for the brake is required in addition to the relay cables described above. In addition, a separate power supply is required for releasing the brake. For details, refer to "AC Servo Actuator RSF Supermini Series Manual".

8.2 Connectors

Connectors for CN1 and CN2 connectors of HA-680, and terminal blocks for motor connection and power supply for options are available as follows:

Connector type: CNK-HA68-S1

For CN1 / For CN2 / For motor connection / For power supply.....4 types

Connector type: CNK-HA68-S2

For CN2 / For power supply..... 2 types

Connector for CN1

Mfg by Sumitomo 3M

Connector: 10114-3000PE

Case: 10314-52F0-008

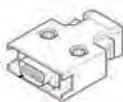

Connector for CN2

Mfg by Sumitomo 3M

Connector: 10126-3000PE

Case: 10326-52F0-008

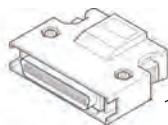

Terminal block for actuator

Mfg by Phoenix contact

Model: MC1.5/6-ST – 3.81

Or

Mfg by OMRON

Model: XW4B – 06B1 – H1



Terminal block for power supply

Mfg by Phoenix contact

Model: MC1.5/5-ST – 3.81

Or

Mfg by OMRON

Model: XW4B – 05B1 – H1



8.3 Dedicated communication software PSF-520 (free)

This software allows you to set and/or change parameters to the HA-680 drive from your PC.

To change the servo parameters of the driver, connect "CN3" of the HA-680 drive and the PC with dedicated communication software PSF-520 installed with the EIA-232C cross cable (dedicated cable HDM-RS232C: Cable length 1.5 m).

For details of dedicated communication software PSF-520, refer to a separate document, "PSF-520 User's Manual."

Dedicated communication software PSF-520 can be downloaded from our website at <http://www.hds.co.jp/>.

If you do not have an environment to download it from the Internet, please ask one of our branch offices.

Model: PSF-520

Supported OS: Windows/Me/NT/2000/Xp
(note: Windows is the registered trademark of Microsoft.)

Items to be provided:

EIA-232C cross cable

(HDM-RS232C cable length: 1.5m)

HA-680 drive side:

Socket terminal: DF11-2428-SCF (Hirose)

Socket DF11-8DS-2C (Hirose)



Deutschland
Harmonic Drive AG
Hoenbergstraße 14
65555 Limburg/Lahn

T +49 6431 5008-0
F +49 6431 5008-119

info@harmonicdrive.de
www.harmonicdrive.de



Technische Änderungen vorbehalten.